

Panasonic

DVD AUDIO/VIDEO PLAYER

Operating Instructions

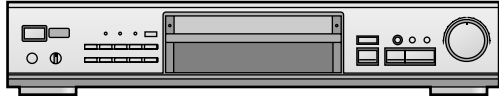

Model No. **DVD-RA60**



Before connecting, operating or adjusting this product, please read these instructions completely.

Please keep this manual for future reference.



This manual was printed with soy based ink.

The region number of this unit is "1". You can play DVD-Video marked "1", "ALL", or with a region number including "1".

e.g.



The servicenter list and warranty can be found on pages 28 and 29.

En la página 31 hay una guía de referencia rápida en español.

Dear customer

Thank you for purchasing this product.
For optimum performance and safety, please read these instructions carefully.

Operations in these instructions are described mainly with the remote control, but you can do the operations on the main unit if the controls are the same.

Getting started

CAUTION!

THIS PRODUCT UTILIZES A LASER.
USE OF CONTROLS OR ADJUSTMENTS OR PERFORMANCE OF PROCEDURES OTHER THAN THOSE SPECIFIED HEREIN MAY RESULT IN HAZARDOUS RADIATION EXPOSURE.
DO NOT OPEN COVERS AND DO NOT REPAIR YOURSELF. REFER SERVICING TO QUALIFIED PERSONNEL.

WARNING:

TO REDUCE THE RISK OF FIRE, ELECTRIC SHOCK OR PRODUCT DAMAGE, DO NOT EXPOSE THIS APPARATUS TO RAIN, MOISTURE, DRIPPING OR SPLASHING AND THAT NO OBJECTS FILLED WITH LIQUIDS, SUCH AS VASES, SHALL BE PLACED ON THE APPARATUS.



CAUTION: TO REDUCE THE RISK OF ELECTRIC SHOCK, DO NOT REMOVE SCREWS. NO USER-SERVICEABLE PARTS INSIDE.
REFER SERVICING TO QUALIFIED SERVICE PERSONNEL.



The lightning flash with arrowhead symbol, within an equilateral triangle, is intended to alert the user to the presence of uninsulated "dangerous voltage" within the product's enclosure that may be of sufficient magnitude to constitute a risk of electric shock to persons.



The exclamation point within an equilateral triangle is intended to alert the user to the presence of important operating and maintenance (servicing) instructions in the literature accompanying the appliance.

CAUTION:

This equipment has been tested and found to comply with the limits for a Class B digital device, pursuant to Part 15 of the FCC Rules.

These limits are designed to provide reasonable protection against harmful interference in a residential installation. This equipment generates, uses and can radiate radio frequency energy and, if not installed and used in accordance with the instructions, may cause harmful interference to radio communications. However, there is no guarantee that interference will not occur in a particular installation. If this equipment does cause harmful interference to radio or television reception, which can be determined by turning the equipment off and on, the user is encouraged to try to correct the interference by one or more of the following measures:

- Reorient or relocate the receiving antenna.
- Increase the separation between the equipment and receiver.
- Connect the equipment into an outlet on a circuit different from that to which the receiver is connected.
- Consult the dealer or an experienced radio/TV technician for help.

Any unauthorized changes or modifications to this equipment would void the user's authority to operate this device.

This device complies with Part 15 of the FCC Rules. Operation is subject to the following two conditions: (1) This device may not cause harmful interference, and (2) this device must accept any interference received, including interference that may cause undesired operation.

DANGER	- VISIBLE AND INVISIBLE LASER RADIATION WHEN OPEN. AVOID DIRECT EXPOSURE TO BEAM. (FDA 21 CFR)
CAUTION	- VISIBLE AND INVISIBLE LASER RADIATION WHEN OPEN. AVOID EXPOSURE TO BEAM. (IEC 60825-1)
ATTENTION	- RAYONNEMENT LASER VISIBLE ET INVISIBLE EN CAS D'OUVERTURE. EXPOSITION DANGEREUSE AU FAISCEAU.
ADVARSEL	- SYNLIG OG USYNLIG LASERSTRÅLING VED ÅBNING. UNNGÅ UDSÆTTELSE FOR STRÅLING.
VARO!	- AVATTAESSA OLET ÄLTTIINÄ NÄKYVÄÄ JA NÄKYMÄTÖN LASERSÄTELYLLE. ÄLÄ KATSO SÄTEESEEN.
VARNING	- SYNLIG OCH OSYNLIG LASERSTRÅLNING NÄR DENNA DEL ÄR ÖPPNAD. BETRÄKTA EJ STRÅLEN.
ADVARSEL	- SYNLIG OG USYNLIG LASERSTRÅLING NÄR DEKSEL ÅPNES. UNNGÅ EKSPONERING FOR STRÅLEN.
VORSICHT	- SICHTBARE UND UNSICHTBARE LASERSTRAHLUNG, WENN ABDECKUNG GEÖFFNET. NICHT DEM STRAHL AUSSETZEN.
注意	- 打开时有可见及不可见激光辐射。避免激光束照射。
注意	- ここを開くと可視及び不可視のレーザー光が出ます。ビームを直接見たり、照ったりしないでください。 RQLS0233

(Inside of product)

Accessories

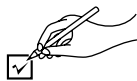

Please check and identify the supplied accessories. Use numbers indicated in parentheses when asking for replacement parts.

To order accessories contact 1-800-332-5368 or web site (<http://www.panasonic.com>).

Remote control 1
(N2QAJB000027)



Batteries 2
for remote control

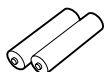

AC power supply cord 1
(RJA0065-A)

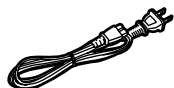

Audio/video cable 1
(VJA0788-D)

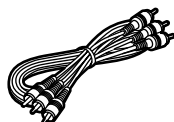

Note

The included AC power supply cord is for use with this unit only. Do not use it with other equipment.

Listening caution



Selecting fine audio equipment such as the unit you've just purchased is only the start of your musical enjoyment. Now it's time to consider how you can maximize the fun and excitement your equipment offers. This manufacturer and the Electronic Industries Association's Consumer Electronics Group want you to get the most out of your equipment by playing it at a safe level. One that lets the sound come through loud and clear without annoying blaring or distortion—and, most importantly, without affecting your sensitive hearing.

We recommend you to avoid prolonged exposure to excessive noise.

Sound can be deceiving. Over time your hearing "comfort level" adapts to higher volumes of sound. So what sounds "normal" can actually be loud and harmful to your hearing.

Guard against this by setting your equipment at a safe level BEFORE your hearing adapts.

To establish a safe level:

- Start your volume control at a low setting.
- Slowly increase the sound until you can hear it comfortably and clearly, and without distortion.

Once you have established a comfortable sound level:

- Set the dial and leave it there.

Taking a minute to do this now will help to prevent hearing damage or loss in the future. After all, we want you listening for a lifetime.

Table of contents

Getting started

Accessories	3
IMPORTANT SAFETY INSTRUCTIONS	4
Disc information	5
The remote control	5
Connection to a television	6
Selecting TV screen type	7
Control reference guide	8

Basic operations

Basic play	9
Playing MP3 discs	9
Resume function	10
Starting play from a selected title or track	10
Skipping chapters or tracks	10
Frame-by-frame viewing	10
Fast forward and rewind—SEARCH	10
Slow-motion play	10
Selecting groups to play	11
Selecting still pictures—Page Skip	11
To enjoy even higher quality sound—AUDIO ONLY	11
Using headphones	11
Enjoying virtual surround effects with 2 speakers or headphones (ADVANCED SURROUND (V.S.S.))	11
CINEMA	11

Advanced operations

Changing the play sequence	12
All group play	12
Random play	12
Program play	13
Repeat play	14
A-B repeat play	14
Repeat play	14
Changing soundtracks, subtitle languages and angles	15
Using On-Screen Menu Icons	16
Common procedures	16
Icons for disc information	17
Shuttle screen	17
Icons for unit information	18
Changing settings	19
Common procedures	20
Entering a password (Ratings)	20
Speaker setting	20
Digital output	21

Home Theater

Home Theater	22
Recording to cassette tapes or digital recording equipment	22
Connecting an amplifier with 5.1-channel audio input terminals	23
Connecting an amplifier with a built-in decoder or a decoder-amplifier combination	23
Connecting an analog amplifier or system component	24
Connecting a digital amplifier or system component	24
Disc handling	24

Reference

Glossary	25
Troubleshooting guide	26
Maintenance	27
Servicenter List	28
Limited Warranty	29
Product Service	29
Language code list	30
Guía de referencia rápida en español (Spanish Quick Reference)	31
Specifications	Back cover

IMPORTANT SAFETY INSTRUCTIONS

Read these operating instructions carefully before using the unit. Follow the safety instructions on the unit and the safety precautions listed below. Keep these operating instructions handy for future reference.

Safety

1. **Power source**—Connect the unit to a power source of the type described in these instructions or as marked on the unit.
2. **Polarization**—The unit is equipped with a polarized power plug where one blade is wider than the other. This safety feature ensures that the plug fits into your household AC outlet only one way. If the plug doesn't fit one way, try reversing it. If the plug still doesn't fit, contact an electrician to replace the obsolete outlet. Do not attempt to defeat the safety purpose of the plug.
3. **Power cord protection**—Route the AC power supply cord so that it will not be walked on or pinched by items placed on or against it. Never take hold of the plug or cord with wet hands. Always grasp the plug body firmly when connecting and disconnecting it.
4. **Overloading**—When connecting the AC power supply cord, be careful not to overload the household AC outlet, extension cord, or outlet from any other device as this can result in fire or electric shock.
5. **Nonuse periods**—Turn the unit off when it is not in use. Unplug the unit from the household AC outlet if it is not to be used for a long time. Unplug the unit during lightning storms.
6. **Attachments and accessories**—Use only the attachments and accessories recommended in these operating instructions.

Installation

Placement

1. **Ventilation**—Situate the unit so that it receives proper ventilation. Do not install in a confined space such as a bookcase or cabinet. Allow at least 10 cm (4 inches) clearance from the rear of the unit. To prevent the risk of electric shock or fire due to overheating ensure curtains and other materials do not obstruct the unit's ventilation.
2. **Foreign material**—Ensure objects and liquids do not get into the unit. Avoid exposing the unit to excessive smoke, dust, mechanical vibration, and shock.
3. **Magnetism**—Situate the unit away from equipment and devices that generate strong magnetic fields.
4. **Stacking**—Do not place heavy objects on top of this unit.
5. **Surface**—Place the unit on a flat, level surface.
6. **Carts and stands**—Use the unit only with carts and stands recommended by the manufacturer. Move carts with care. Sudden stops, excessive force, and uneven surfaces can cause carts to overturn.
7. **Wall and ceiling mounting**—Do not mount the unit on walls or ceilings unless specified in the instructions.



Do not place the unit on amplifiers or equipment that may become hot.

The heat can damage the unit.

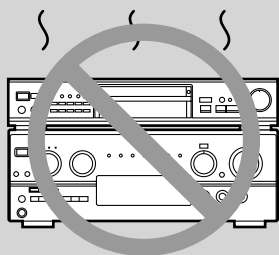

Environment

1. **Water and moisture**—Do not use the unit near water, such as near a bathtub or swimming pool. Avoid damp basements.
2. **Heat**—Situate the unit away from heat sources, such as radiators. Do not situate where temperatures fall below 5°C (41°F) or rise above 35°C (95°F).

Maintenance

(See page 27 for details.)

Unplug the unit from the household AC outlet before cleaning. Clean with a damp cloth. Do not use abrasive pads, scouring powders, or solvents.

Service

1. **Damage requiring service**—The unit should be serviced by qualified service personnel if:
 - (a) The AC power supply cord or the plug has been damaged; or
 - (b) Objects or liquids have gotten into the unit; or
 - (c) The unit has been exposed to rain; or
 - (d) The unit does not operate normally or exhibits a marked change in performance; or
 - (e) The unit has been dropped or the cabinet damaged.
2. **Servicing**—Do not attempt to service the unit beyond that described in these operating instructions. Refer all other servicing to authorized servicing personnel.
3. **Replacement parts**—When parts need replacing ensure the servicer uses parts specified by the manufacturer or parts that have the same characteristics as the original parts. Unauthorized substitutes may result in fire, electric shock, or other hazards.
4. **Safety check**—After repairs or service, ask the servicer to perform safety checks to confirm that the unit is in proper working condition.

User memo:

DATE OF PURCHASE _____
DEALER NAME _____
DEALER ADDRESS _____
TELEPHONE NUMBER _____

The model number and serial number of this product can be found on either the back or the bottom of the unit. Please note them in the space provided below and keep for future reference.

MODEL NUMBER _____ DVD-RA60 _____
SERIAL NUMBER _____

Discs that can be played

Disc type	Logo	Indication used in instructions
DVD-Audio		DVD-A
DVD-Video		DVD-V
DVD-R		
Video CD		VCD
Audio CD		CD

Discs that cannot be played

PAL discs (the audio on DVD-Audio can be played), DVD-ROM, DVD-RAM, CD-ROM, CDV, CD-G, +RW, DVD-RW, CVD, SVCD, SACD, Divx Video Discs and Photo CD.

DVDs that can be played

This unit has a Dolby Digital decoder so you can play DVDs with this mark.

This unit has a DTS decoder so you can play DVDs with this mark.

DVD-R discs

Panasonic DVD-R recorded and finalized on a Panasonic DVD video recorder are played as DVD-Video on this unit. It may not be possible to play these discs in all cases due to the type of disc or condition of the recording.

Region Management Information (DVD-Video only)

This unit responds to the Region Management Information recorded on DVD-Video. This unit's region number is "1". You cannot play the disc if the region number on the DVD-Video does not correspond to the region number on the unit.

You can play discs with labels containing the region number "1" and "ALL". Read the disc's instructions carefully.

e.g.



Playing DVDs and Video CDs

The producer of the material can control how these discs are played. This means that you may not be able to control play of a disc with some operations described in these operating instructions. Read the disc's instructions carefully.

Batteries

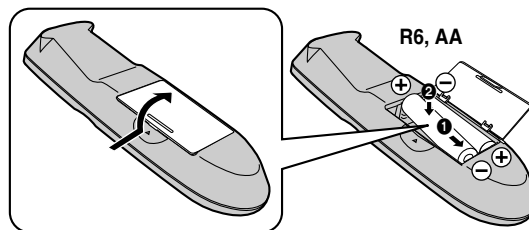

- Insert so the poles (+ and -) match those in the remote control.
- Do not use rechargeable type batteries.

Do not;

- mix old and new batteries.
 - use different types at the same time.
 - heat or expose to flame.
 - take apart or short circuit.
 - attempt to recharge alkaline or manganese batteries.
 - use batteries if the covering has been peeled off.
- Mishandling of batteries can cause electrolyte leakage which can damage items the fluid contacts and may cause a fire. If electrolyte leaks from the batteries, consult your dealer. Wash thoroughly with water if electrolyte comes in contact with any part of your body.

Remove if the remote control is not going to be used for a long period of time. Store in a cool, dark place.

Replace if the unit does not respond to the remote control even when held close to the front panel.

Use

Remote control signal sensor

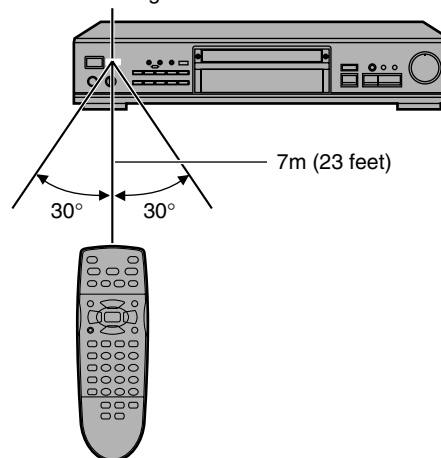

Aim at the sensor, avoiding obstacles, at a maximum range of 7 m (23 feet) directly in front of the unit.

- Keep the transmission window and the unit's sensor free from dust.
- Operation can be affected by strong light sources, such as direct sunlight, and the glass doors on cabinets.

Do not;

- put heavy objects on the remote control.
- take the remote control apart.
- spill liquids onto the remote control.

Connection to a television

Although the audio on most DVDs is designed to be played through six speakers and this unit's factory settings assume this setup, the following describes the basic connections that allow you to enjoy sound through your television's speakers. To get the full benefit from the powerful 5.1-channel audio found on DVDs, you should connect an amplifier and six speakers. Descriptions of this kind of connection start on page 22.

Before connection

- Disconnect the AC power supply cord.
- Refer to the television's operating instructions.

Getting started

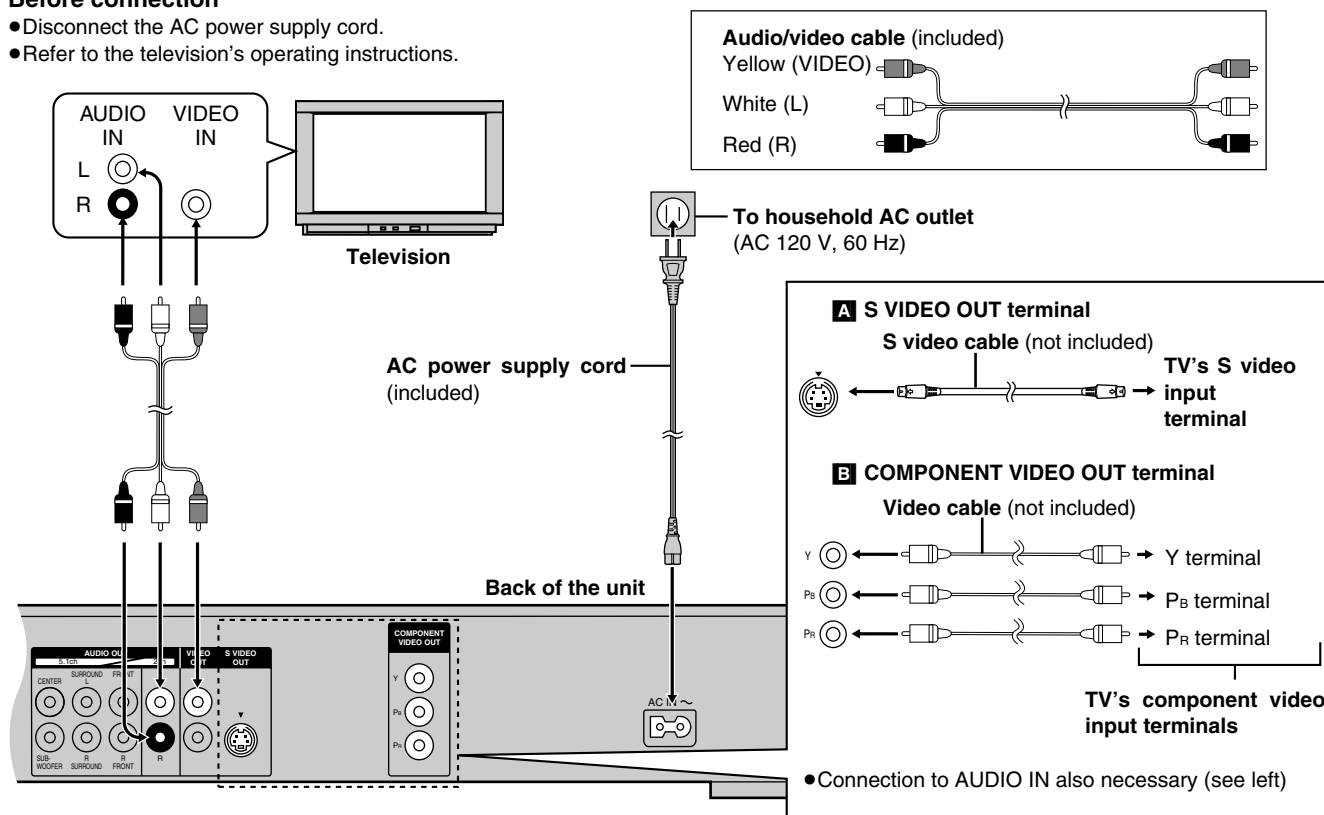

A S VIDEO OUT terminal

The S-video terminal achieves a more vivid picture than the VIDEO OUT terminal by separating the chrominance (C) and luminance (Y) signals. (Actual results depend on the television.)

B COMPONENT VIDEO OUT terminal

These terminals provide a purer picture than the S VIDEO OUT terminal. Connection using these terminals outputs the color difference signals (P_B/P_R) and luminance signal (Y) separately in order to achieve high fidelity in reproducing colors.

- The description of the component video input terminals depends on the television or monitor (e.g. Y/P_B/P_R, Y/B-Y/R-Y, Y/C_B/C_R). Connect to terminals of the same color.
- After making this connection, change the black level for a better picture (➔ page 19, Video—Black Level Control).

Conserving power

This unit consumes a small amount of power, even when it is turned off (approx. 2 W). To save power when the unit is not to be used for a long time, unplug it from the household AC outlet.

Connect Your Unit Directly To Your Television.

Do not connect the unit through your video cassette recorder when setting up your home entertainment system. The picture may not be displayed correctly due to the copy guard.

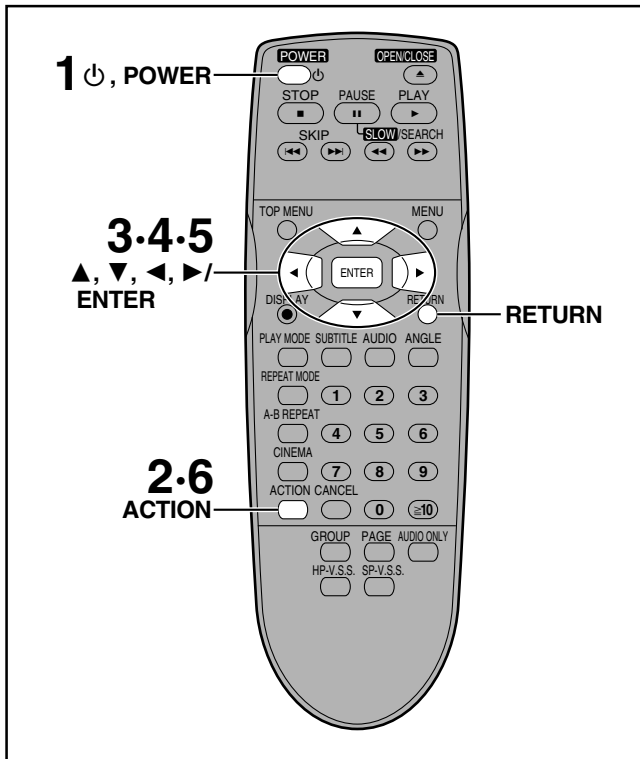

Remote control only

Change the setting to suit your television.

The menu language is set to English, but you can change it to French or Spanish (→ page 19, Display—Menu Language). English is used in the examples.

Preparation

Turn on the television and select the appropriate video input on the television to suit the connections for the player.

1 Press [**POWER**] to turn on the unit.

2 Press [**ACTION**] to show the menus.

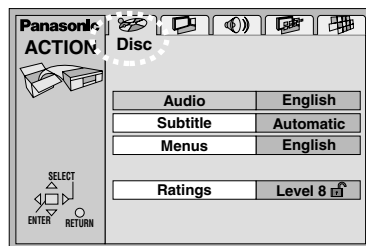

3 Press [**Left/Right**] to select the “Video” tab.

4 Press [**Up/Down**] to select “TV Aspect” and press [**ENTER**].

5 Press [**Up/Down**] to select the item and press [**ENTER**].

- **4:3 Pan&Scan** (Factory preset)
Select if you have a regular television and to view 16:9 software* in the pan and scan style.



*16:9 software prohibited from being shown in the pan and scan style will appear in the letterbox style despite the setting here.

- **4:3 Letterbox**
Select if you have a regular television and to view 16:9 software in the letterbox style.



- **16:9**
Select if you have a widescreen (16:9) television. Use the television's screen modes to change the way the picture is shown.

6 Press [**ACTION**] to end the settings.

To return to the previous screen
Press [**RETURN**].

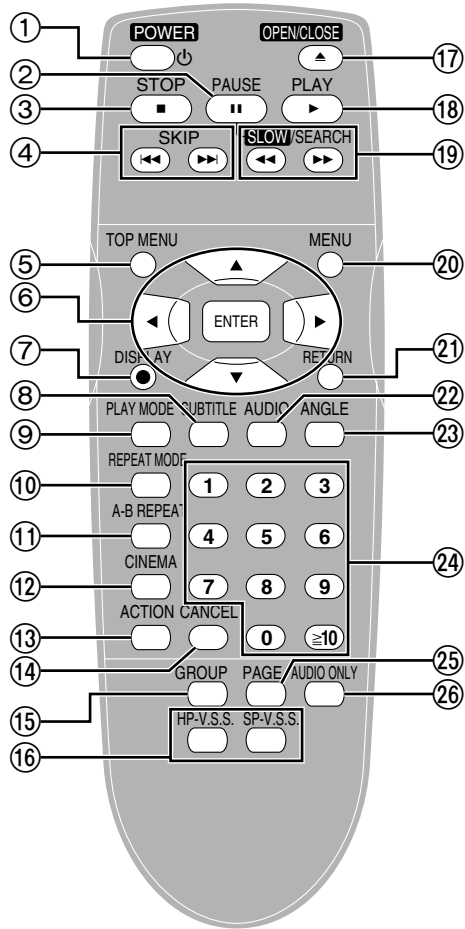

Remote control

Page

① Standby/on switch (⏻, POWER)	7
Press to switch the unit from on to standby mode or vice versa. In standby mode, the unit is still consuming a small amount of power.	
② Pause button (⏸, PAUSE)	9
③ Stop button (■, STOP)	9
④ Skip buttons (⏮, ⏭) SKIP	10
⑤ Top menu button (TOP MENU)	9
⑥ Cursor buttons (▲, ▼, ◀, ▶)/Enter button (ENTER)	7
⑦ Display button (DISPLAY)	16
⑧ Subtitle button (SUBTITLE)	15
⑨ Play mode button (PLAY MODE)	12
⑩ Repeat mode button (REPEAT MODE)	14
⑪ A-B repeat button (A-B REPEAT)	14
⑫ Cinema button (CINEMA)	11
⑬ Action button (ACTION)	7, 20
⑭ Cancel button (CANCEL)	13
⑮ Group button (GROUP)	11
⑯ Headphone and Speaker V.S.S. buttons (HP-V.S.S., SP-V.S.S.)	11
⑰ Open/Close button (▲, OPEN/CLOSE)	9
⑱ Play button (▶, PLAY)	9
⑲ Slow/Search buttons (⏮, ⏭) SLOW/SEARCH	10
⑳ Menu button (MENU)	9
㉑ Return button (RETURN)	7
㉒ Audio button (AUDIO)	15
㉓ Angle button (ANGLE)	15
㉔ Numbered buttons (1-9, 0, >=10)	9
㉕ Page button (PAGE)	11
㉖ Audio only button (AUDIO ONLY)	11

Main unit

Buttons such as ❶ function the same as the controls on the remote control.

Page

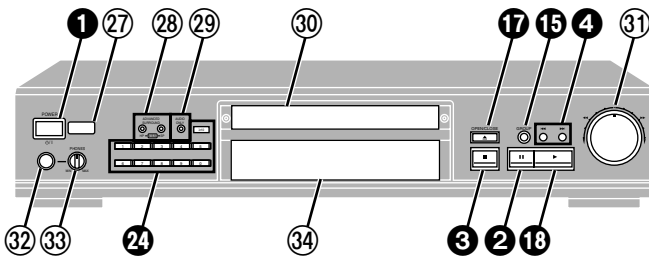

⑳ Remote control signal sensor	5
㉑ Headphone and Speaker V.S.S. buttons/indicators (HP-V.S.S., SP-V.S.S.)	11
㉒ Audio only button/indicator (AUDIO ONLY)	11
㉓ Disc tray	9
㉔ Shuttle dial (⏮, ⏭)	10
㉕ Headphone jack	11
㉖ Headphone level control (PHONES)	11
㉗ Display	

Basic play

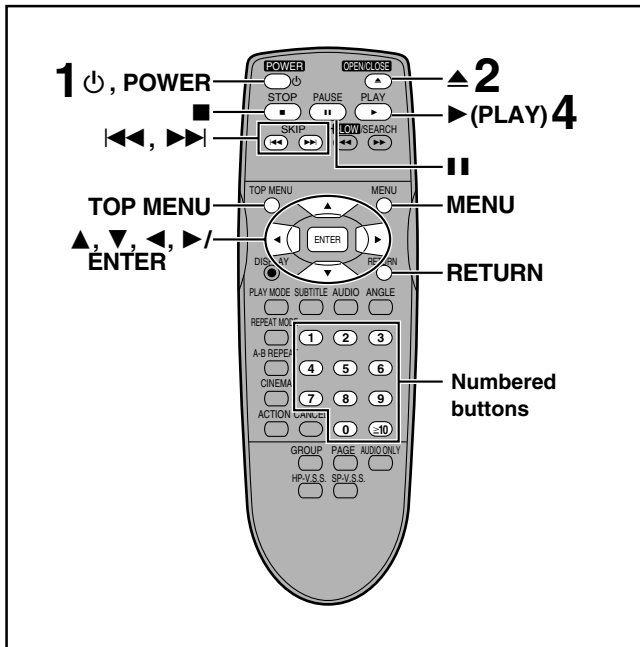

DVD-A DVD-V VCD CD

Preparation

Turn on the television and select the appropriate video input on the television to suit the connections for the player.

- 1 Press [POWER] to turn on the unit.
- 2 Press [OPEN/CLOSE] to open the disc tray.
- 3 Place the disc on the disc tray.

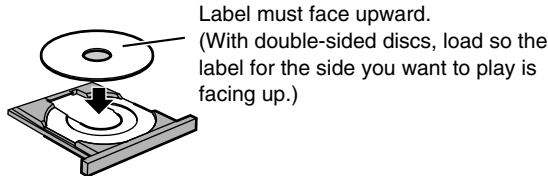

- 4 Press [PLAY].
The disc tray closes and play begins.

To stop play

Press [STOP] (→ page 10, Resume function).

To pause play

Press [PAUSE] during play.

Press [PLAY] to restart play.

Playing CD-R and CD-RW

This unit can play CD-DA (digital audio) and Video CD format audio CD-R and CD-RW that have been finalized* upon completion of recording.

It may not be able to play some CD-R or CD-RW due to the condition of the recording.

*Finalizing is a process that enables CD-R/CD-RW players to play audio CD-R and CD-RW.

Note

- If "⊘" appears on the television
The operation is prohibited by the unit or disc.
- The disc continues to rotate while the menu is displayed even after you finish playing an item. Press [STOP] when you finish to preserve the unit's motor and your television screen.
- Volume may be lower when playing DVDs than when playing other discs or during television broadcasts.
If you turn the volume up on the television or amplifier, be sure to reduce the volume again before playing other sources so that a sudden increase in output does not occur.

Auto power-off

The unit switches to the standby mode after about 30 minutes in the stop mode.

When a menu appears on the television

DVD-A DVD-V VCD

Press the numbered buttons to select an item.

To select a 2-digit number

Example: To select item 23, press [≥10] → [2] → [3].

- When playing DVDs, you can also use [▲], [▼], [◀], [▶] to select items. Press [ENTER] to confirm your selection.

Play of the selected item now begins.

Other buttons used to operate menus

Read the disc's instructions for further details about operation.

[▶▶]: Shows the next menu.

[◀◀]: Shows the previous menu.

[RETURN]: Shows the menu screen. VCD

[TOP MENU]: Shows the first menu screen. DVD-A DVD-V

[MENU]: Shows the menu screen. DVD-V

DVD menus

DVD-Video can have several menus. The menu displayed when you press [TOP MENU] may be different from the menu displayed when you press [MENU].

Playing MP3 discs

CD

Discs recorded using MP3 differ to CDs in the following ways.

- Structure of the disc (example)

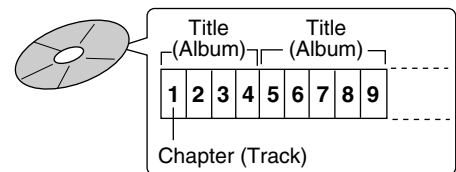

The display during play is different



The information displayed in the On-Screen Menu Icons is different

Total number of chapters

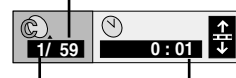

Chapter playing Elapsed playing time (cannot be changed)

The method of specifying a chapter to play is different

Press [ENTER] after pressing the numbered buttons.

For example, to select chapter 23, press [2] → [3] → [ENTER].

You do not have to press [≥10].

Repeat play

You can repeat chapters or titles.

Limitations on MP3 play

- You cannot use program or random play.
- The time information may not be displayed correctly.
- If both MP3 and CD-DA data is recorded on the disc, only the data type used for the first track is played.
- It may take some time for play to start if the disc includes still picture data or if there are many folders on the disc.
- Noise may be output if a file is suffixed ".MP3" or ".mp3" but is not actually an MP3 file.
- This unit is not compatible with ID3 tags and packet-write format.

Refer to the glossary on page 25 for more information about MP3.

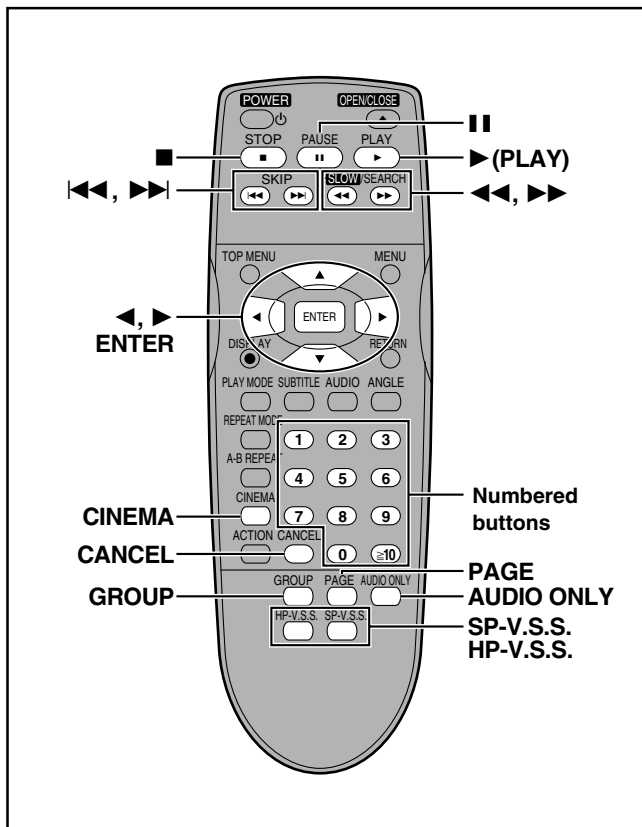

Resume function

DVD-A DVD-V VCD CD

The position you stopped play at is recorded by the unit when “▷” is flashing on the unit’s display.

While “▷” is flashing on the unit’s display, press [▶] (PLAY) to start play from where you stopped it.

If you are playing DVD-Video, the message “Press PLAY to Preview Chapters” appears.

Press [▶] (PLAY) while the message is displayed and the beginning portions of each chapter up to the current one are played. Full play resumes from the point where you stopped play.

(This feature works only within a title.)

If you do not press [▶] (PLAY), the message disappears and play starts from where you stopped it.

To cancel

Press [■] until “▷” disappears from the unit’s display.

Note

- The resume function does not work if the disc’s play time is not displayed.
- The position is cleared when the disc tray is opened.

Starting play from a selected title or track

DVD-A DVD-V VCD CD

Press the numbered buttons to select the item.

To select a 2-digit number

Example: To select track 23, press [≥10] → [2] → [3].

Play starts from the selected item.

Note

This works only when stopped with some discs.

Skipping chapters or tracks

DVD-A DVD-V VCD CD

During play or while paused

Press [◀◀] or [▶▶].

- Each press increases the number of skips.

Frame-by-frame viewing

DVD-A DVD-V VCD

Remote control only

While paused

Press [◀] or [▶].

The frame changes each time you press the buttons.

- The frames change in succession if you press and hold the button.
- Pressing [||] also activates forward frame-by-frame.

Fast forward and rewind—SEARCH

DVD-A DVD-V VCD CD

During play

Press [◀◀] or [▶▶].

Turn the shuttle dial [◀◀, ▶▶] on the main unit.

- Play starts again when you release the shuttle dial.
- Audio will be heard during search for most discs. You can turn this audio off if you want to (⇒ page 19, Audio—Audio during Search).

Slow-motion play

DVD-A DVD-V VCD

While paused

Press [◀◀] or [▶▶].

Turn the shuttle dial [◀◀, ▶▶] on the main unit.

- The picture stills again when you release the shuttle dial.

Notes

- The speed of search and slow-motion increases up to 5 steps.
- Press [▶] (PLAY) to restart play.
- You cannot move backwards with Video CD during frame-by-frame and slow-motion.
- Frame-by-frame and slow-motion only work on the moving picture parts of DVD-Audio.
- [◀◀], [◀] or [◀◀]: Backward
[▶▶], [▶] or [▶▶]: Forward

When playing Video CDs with playback control

Turning the shuttle dial or pressing buttons to perform skip, search or slow-motion may take you to a menu screen.

Selecting groups to play

DVD-A

The tracks on DVD-Audio are divided into groups. How these groups are played differs with the disc so read the instructions that came with the disc for further details.

1 Press [GROUP].

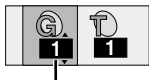

The group number changes each time you press the button.

2 Press [ENTER].

3 Press the numbered buttons to select the track number and press [ENTER].

The selected group and track begin to play.

Playing all the groups in succession (→ page 12)

Playing bonus groups

Some discs contain bonus groups. To enjoy these groups you may have to enter a password. Refer to the disc's jacket.

1. Press [GROUP] to select the bonus group and press [ENTER].
2. Enter the 4-digit password with the numbered buttons and press [ENTER].
 - If you enter the wrong password, you can erase a digit by pressing [CANCEL].
3. Press the numbered buttons to select a track and press [ENTER].

- The bonus group can be played as many times as you like after the password has been entered until the disc is removed from the unit.

Selecting still pictures—Page Skip

DVD-A

Remote control only

During play

Press [PAGE].

e.g. Page 1



The page changes each time you press the button.

To enjoy even higher quality sound—AUDIO ONLY

DVD-A DVD-V VCD CD

You can enjoy higher quality audio by stopping the video signal.

Press [AUDIO ONLY].

- The AUDIO ONLY indicator on the main unit lights.
- AUDIO ONLY is canceled if you press the button again or turn the unit off. The light goes out.

Note

- Video signals are output while the disc is stopped and when operations such as searching are performed. The television screen can appear unusual while video signals are not being output.
- The television may be distorted when video signals are turned on and off when you turn AUDIO ONLY on and off, but this is not a malfunction.

Using headphones

1 Set [PHONES] to “MIN” and connect the headphones (not included).

Headphone plug type: 6.3 mm (1/4”) stereo

2 Adjust headphone volume with [PHONES].

Note

Avoid listening for prolonged periods of time to prevent hearing damage.

Enjoying virtual surround effects with 2 speakers or headphones (ADVANCED SURROUND (V.S.S.))

DVD-V VCD

SP-V.S.S.: Dolby Digital, DTS, MPEG, Linear PCM, 2-channel or over only

HP-V.S.S.: Dolby Digital, MPEG, Linear PCM, 2-channel or over only

Use ADVANCED SURROUND (V.S.S.) (Virtual Surround Sound) to enjoy a surround-like effect if you are using 2 front speakers or headphones.

If you are playing a disc with surround effects recorded on it, the effect is broadened and sound seems to come from virtual speakers on either side.

During play

Press [SP-V.S.S.] or [HP-V.S.S.].

Each time you press the button:

- SP 1/HP 1: Natural effect
- ↓
- SP 2/HP 2: Emphasized effect
- ↓
- SP OFF/HP OFF: Cancel (Factory preset)

Note

- Advanced Surround will not work, or will have less effect with some discs, even if you select “1” or “2”.
- Turn off the surround sound effects on the equipment you have connected when using this effect.
- Turn Advanced Surround off if it causes distortion.
- Output from this unit will be in stereo (two channels) when V.S.S. is on.

Optimum seating position

<When using the television's speakers>
Distance A =
Television's width

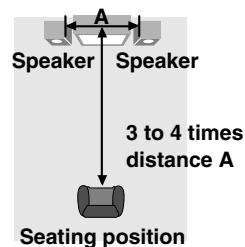

CINEMA

DVD-A DVD-V VCD

Remote control only

You can enjoy better pictures by changing the picture quality.

Press [CINEMA].

Each time you press the button:

- C: Cinema mode: Mellows movies, enhances detail in dark scenes. Indication on the unit's display lights up.



N: Normal mode (Factory preset)

You can make finer adjustments to the picture if desired (→ page 18, Digital picture mode—User mode).

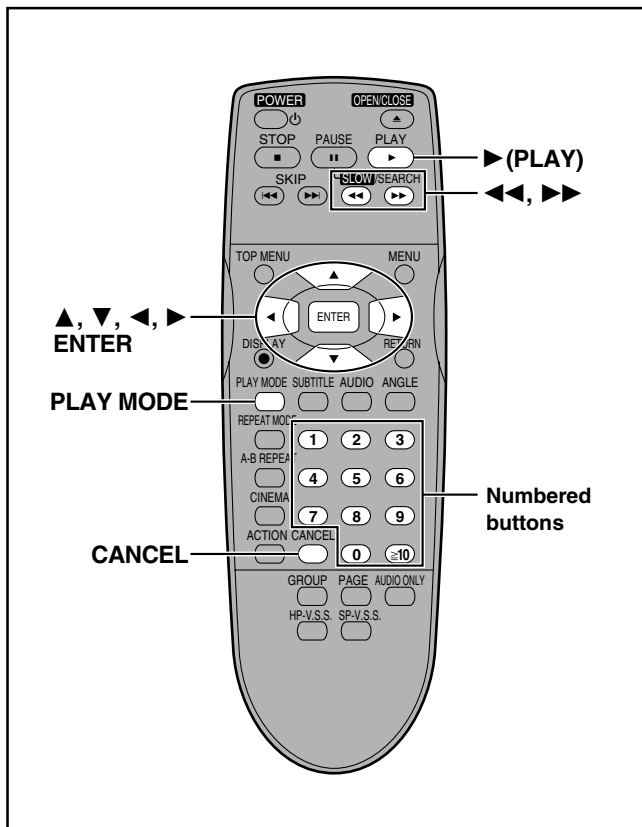

Random play

DVD-A VCD CD

Remote control only

The unit plays the tracks on a disc in random order.

- 1 While stopped
Press [PLAY MODE] until the random play screen appears.

e.g. DVD-Audio
(three groups)

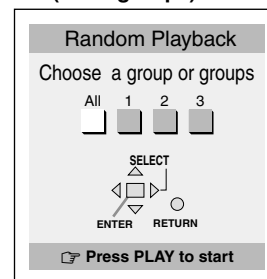

- 2 **DVD-Audio only**
Press [◀, ▶] to select a group and press [ENTER].

- You can select more than one group.
- You can also select groups with the numbered buttons.
- If you select bonus groups, you will have to enter a 4-digit password (→ page 11).
- To clear a group, select it and press [ENTER].

- 3 Press [▶] (PLAY).
Play now begins in random order.

To exit random mode

Press [PLAY MODE] while stopped until the random play screen disappears.

All group play

DVD-A

Remote control only

The unit plays the tracks in all the groups on a disc.

- 1 While stopped
Press [PLAY MODE] until the all group play screen appears.



- 2 Press [▶] (PLAY).

To exit all group mode

Press [PLAY MODE] while stopped until the all group screen disappears.

Program play

DVD-A VCD CD

Remote control only

You can select up to 32 tracks to play in the order you choose.

- 1 While stopped**
Press [PLAY MODE] until the program play screen appears.

e.g. DVD-Audio

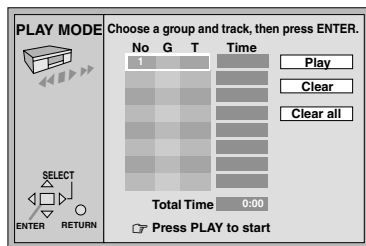

- 2 Press [ENTER].**
- 3**
DVD-Audio only
Press [▲, ▼] to select a group and press [ENTER].

• If you select bonus groups, you will have to enter a 4-digit password (→ page 11).

- 4 Press [▲, ▼] to select a track and press [ENTER].**

Each time you press the buttons,

1 ↔ 2 ↔ ↔ ALL

- Repeat steps 2, 3 and 4 to program other tracks.
- You can also select a group or track with the numbered buttons.
- “Total Time” tells you the total time of the programmed tracks.
- All the tracks on a disc are selected when you select “ALL” (all the tracks in the selected group with DVD-Audio).

- 5 Press [▶] (PLAY).**

Play now begins in the programmed sequence.

To add or change tracks

Press [▲, ▼] to select an available item, then repeat steps 2–4.

To move to the page before or after the one shown

Press [◀◀] or [▶▶].

To clear the programmed tracks one by one

Press [▲, ▼] to select the item number (No) and press [CANCEL]. (Alternatively, you can select “Clear” with [▲, ▼, ◀, ▶] and press [ENTER].)

To clear the whole program

Move to “Clear all” with [▲, ▼, ◀, ▶] and press [ENTER].

The whole program is also cleared when the unit is turned off or the disc tray is opened.

To exit the program mode

Press [PLAY MODE] while stopped until the program play screen disappears.

- The program is retained in memory.

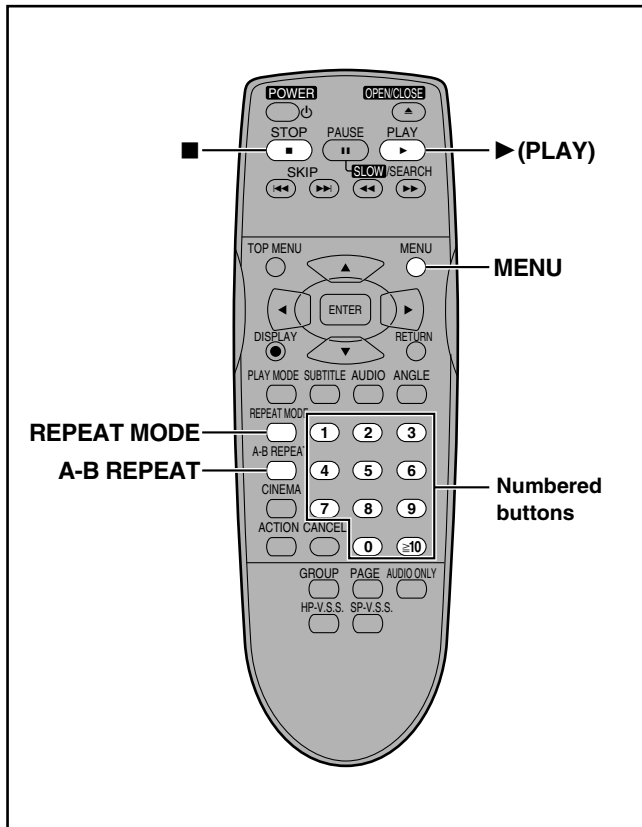

DVD-A DVD-V VCD CD

Remote control only

A-B repeat play

You can repeat a section between points A and B within a title or track.

- 1 During play
Press [A-B REPEAT] at the starting point (A).



- 2 Press [A-B REPEAT] at the finishing point (B).

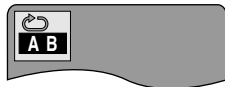

To cancel

Press [A-B REPEAT] until "⏮️ **" is displayed.

Note

- A-B repeat does not work if the DVD's elapsed play time is not shown on the unit's display.
- Some subtitles recorded around point A or B may fail to appear (DVD).
- The unit automatically determines the end of a title/track as point B when the end of the title/track is reached.

Repeat play

During play

Press [REPEAT MODE].

Each time you press the button:

e.g. DVD-Video

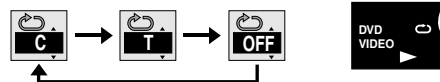

• DVD-Audio

Track (T) → Whole group (G) → OFF

During All group, Program, or Random play modes, "A" is displayed instead of "G".

• DVD-Video

Chapter (C) → Title (T) → OFF

• Video CD/CD

Track (T) → Entire disc (A) → OFF

If the Video CD has playback control

Cancel menu play first.

1. Press [■] so "PBC PLAY" is cleared from the unit's display.
2. Press the numbered buttons to select a track to start play.
3. Press [REPEAT MODE] (⇨ above).

To return to menu play, press [■] and press [MENU].

Note

- Repeat play may not work as desired with some DVDs.
- Repeat play does not work if the disc's elapsed play time is not shown on the unit's display.
- You cannot use repeat play to repeat an entire DVD-Video.

■ To repeat only your favorite tracks

DVD-A VCD CD

1. Program the tracks you want (⇨ page 13).
2. Press [▶] (PLAY). Play will start.
3. Press [REPEAT MODE] to display "⏮️ T" or "⏮️ A".

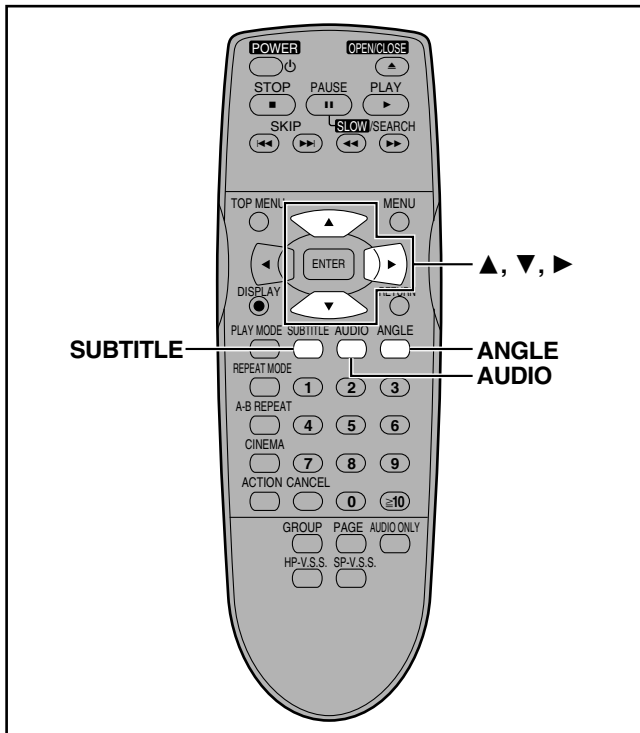

DVD-A | DVD-V

Remote control only

Some DVDs have multiple soundtracks, subtitle languages and camera angles, and you can change these during play.

Soundtracks

During play

Press [AUDIO].

The number changes each time you press the button.



Soundtrack selected

Soundtrack playing

e.g. DVD-Video



Indicates that a multi-channel soundtrack can be down-mixed to two channels.

Lights when a multi-channel soundtrack is playing.

- Play restarts from the beginning of the soundtrack when changing DVD-Audio soundtracks that are accompanied by still pictures.
- Even if a second soundtrack isn't recorded on a DVD-Audio, two soundtrack numbers will normally be shown when you press [AUDIO]. The soundtrack currently playing is number 1.
- You can also use this button to turn the vocals on and off on karaoke discs. Read the disc's instructions for details.

Notes regarding soundtracks and subtitle languages

- “-” or “--” is displayed instead of the language number in circumstances such as when no language is recorded on the disc.
- In some cases, the subtitle language is not changed to the selected one immediately.

Subtitles

During play

Press [SUBTITLE].

The number changes each time you press the button.

DVD-Video

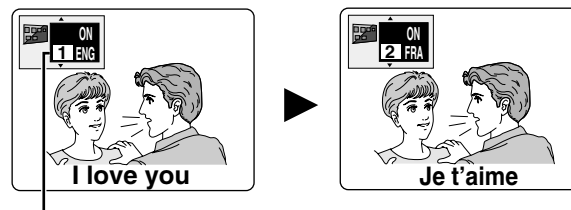

Subtitle language number

To clear/display the subtitles

1. Press [SUBTITLE].
2. Press [▶].
3. Press [▲, ▼] to select “OFF” or “ON”.

Angles

During play

Press [ANGLE].

The number changes each time you press the button.

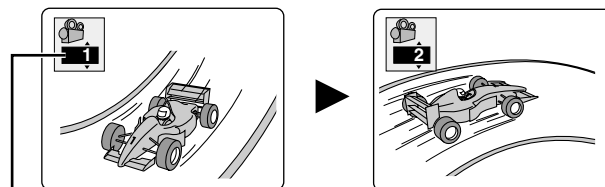

Angle number

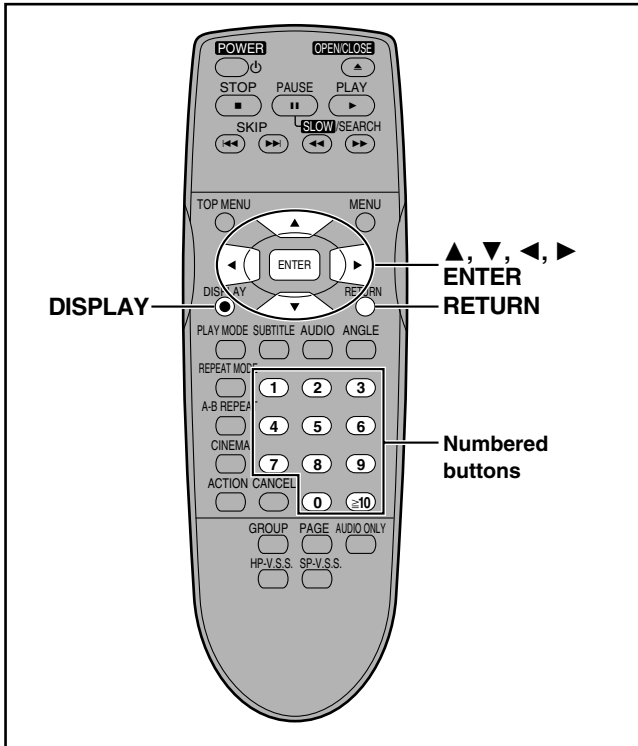

On-Screen Menu Icons are menus that contain information about the disc or unit. These menus allow you to perform operations by changing this information.

Common procedures

DVD-A DVD-V VCD CD

Remote control only

1 Press [DISPLAY].

Each time you press the button:

e.g. DVD-Video

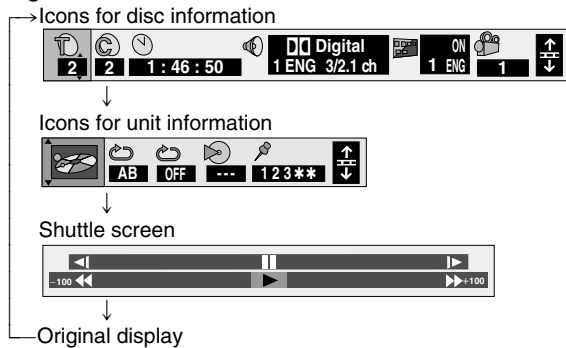

• The screens depend on disc contents.

2 Icons for unit information only

While the leftmost icon is highlighted

Press [▲, ▼] to select the menu.

Each time you press the buttons:

e.g. DVD-Video

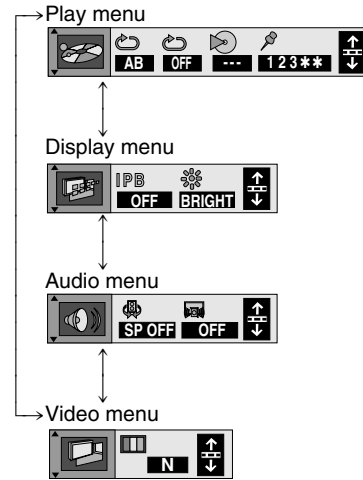

3 Press [◀, ▶] to select the item.

4 Press [▲, ▼] to select the setting.

- Items with “▲” or “▼” above and below can be changed by [▲, ▼].
- Press [ENTER] if the setting does not change after pressing the buttons [▲, ▼].
- Some items require different operations. Read the explanations on the following pages.

For your reference

- Depending on the condition of the unit (playing, stopped, etc.) and the type of software you are playing, there are some items that you cannot select or change.
- When numbers are displayed (e.g. title No.), the numbered buttons are also effective for setting. After entering numbers, press [ENTER] to register the setting.

To clear the icons

Press [RETURN] until the menus disappear.

■ To change the position of the icons

1. Press [◀, ▶] to select the rightmost icon.
2. Press [▲, ▼] to move the icons.
(There are 5 positions)



Icons for disc information

e.g. DVD-Video



Icon	Content
	DVD-A Group number
	DVD-V Title number DVD-A VCD CD Track number
	DVD-V Chapter number
	DVD-A DVD-V Time Select a position to start play by specifying a time with the numbered buttons. DVD-A VCD CD Changing the time display Press [▲ , ▼] to show the elapsed play time, remaining time for the track, or remaining time for the disc/group (DVD-Audio).
	VCD Audio mode LR ↔ L ↔ R ↑
	DVD-A DVD-V a Soundtrack language (See A at right for language abbreviations.) b Audio signal type (See B at right for details.)
	DVD-V Karaoke vocal on/off (Karaoke DVD only) Solo: OFF or ON Duet: OFF, V1+V2, V1 or V2

Icon	Content
	DVD-A DVD-V Subtitle language (See A below for language abbreviations.)
	Subtitles on/off ON ↔ OFF
	DVD-A DVD-V Angle number
	VCD (with playback control only) Menu play Indicates whether menu play (playback control) is on or off.
	DVD-A Still picture number Selected picture is shown during play.

A Audio/Subtitle language

ENG: English	SVE: Swedish	CHI: Chinese
FRA: French	NOR: Norwegian	KOR: Korean
DEU: German	DAN: Danish	MAL: Malay
ITA: Italian	POR: Portuguese	VIE: Vietnamese
ESP: Spanish	RUS: Russian	THA: Thai
NLD: Dutch	JPN: Japanese	*: Others

B Signal type/data

LPCM/PPCM/**D**Digital/DTS/MPEG: Signal type

k (kHz): Sampling frequency

b (bit): Number of bits

ch (channel): Number of channels

Example:

3/2 .1ch

.1: Subwoofer signal
(not displayed if there is no subwoofer signal)

0: No surround
1: Mono surround
2: Stereo surround (left/right)

1: Center
2: Front left+Front right
3: Front left+Front right+Center

Shuttle screen

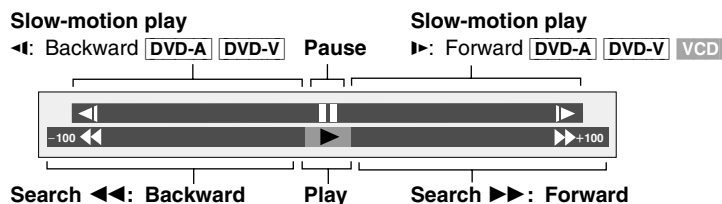





Note



The numbers on either side of the shuttle screen indicate the maximum speeds of the search.

Icons for unit information



 Play menu

Icon	Content
	A-B repeat (⇒ page 14) [ENTER] (start point) ⇒ [ENTER] (finish point) To cancel: [ENTER]
	Repeat play (⇒ page 14) ● DVD-Audio Track (T) ↔ Whole group (G) ↔ OFF ↑ ● DVD-Video Chapter (C) ↔ Title (T) ↔ OFF ↑ ● Video CD/CD Track (T) ↔ Entire disc (A) ↔ OFF ↑
	DVD-A VCD CD Play mode display ---: Normal play RND: Random play PGM: Program play ALL: All group play (DVD-A)
	Marker You can mark up to 5 positions to play again. [ENTER] (The unit is now ready to accept markers.) ----- To mark a position [ENTER] (at the desired point) To mark another position: [◀, ▶] ⇒ [ENTER] ----- To recall a marker: [◀, ▶] ⇒ [ENTER] ----- To erase a marker: [◀, ▶] ⇒ [CANCEL]





 Display menu

Icon	Content
	DVD-V IPB display (⇒ page 25) ON ↔ OFF Displays the picture type (I/P/B) in the still picture mode.
	Display dimmer Changes the brightness of the unit's display. BRIGHT ↔ DIM ↔ AUTO (DVD-A DVD-V VCD)* ↑ *The display is dimmed during play, but brightens when you perform an operations such as slow-motion, search, and pause.

 Audio menu

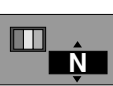
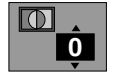
Icon	Content
	DVD-V VCD ADVANCED SURROUND (V.S.S.) mode (⇒ page 11) SP ↔ HP ----- V.S.S. level (⇒ page 11) 1 ↔ 2 ↔ OFF ↑
	DVD-V (Dolby Digital/DTS, 3-channel or over only) Dialogue Enhancer ON ↔ OFF The volume of the dialogue from the center channel is raised when you select "ON".

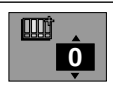



 Video menu

Icon	Content
	DVD-A DVD-V VCD Digital picture mode To select the picture mode: [▲, ▼] N: Normal mode C: Cinema mode (⇒ page 11) U: User mode The following items are also displayed when you select "U".
	Contrast (-7 to +7) Increases the contrast between white and black parts of the picture.
	Brightness (0 to +15) Brightens the picture.
	Sharpness (-6 to +6) Adjust the sharpness of the edges of the vertical lines.
	Color (-7 to +7) Adjust the shade of the picture's color.

Changing settings

This chart shows the settings for this unit. Change the settings to suit your preferences and to suit the unit to the environment in which it is being used. These settings are retained in memory until they are changed, even if the unit is turned off. See page 20 for details on menu operation.

● Underlined items are the factory preset.

Menus	Items	Options
Disc  (Remarks below)	Audio <u>DVD-A</u> <u>DVD-V</u> Choose the audio language.	<u>English</u> French Spanish Original Other ****
	Subtitle <u>DVD-A</u> <u>DVD-V</u> Choose the subtitle language.	<u>Automatic</u> English French Spanish Other ****
	Menus <u>DVD-A</u> <u>DVD-V</u> Choose the language for disc menus.	<u>English</u> French Spanish Other ****
	Ratings <u>DVD-V</u> (page 20) Set a ratings level to limit DVD-Video play. ● The password screen is shown if you choose levels 0 to 7 or if you choose "Ratings" when levels 0 to 7 have been selected. ● Select "Level 0" to prevent play of discs that do not have ratings levels recorded on them.	Setting ratings (When level 8 is selected) 8 <u>No Limit</u> : All DVD-Video can be played. 1 to 7: Prohibits play of DVD-Video with corresponding ratings recorded on them. 0 <u>Lock All</u> : Prohibits play of all DVD-Video. <hr/> Changing ratings (When level 0–7 is selected) Unlock Player Change Password Change Level Temporary Unlock
Video 	TV Aspect (page 7) Choose the setting to suit your television and preference.	<u>4:3 Pan&Scan</u> 4:3 Letterbox 16:9
	Still Mode (page 25) Specify the type of picture shown when paused.	<u>Automatic</u> Field Frame
	Black Level Control Change the black level of the picture if you connected a television through the COMPONENT VIDEO OUT terminals.	<u>Lighter</u> : when connected to a TV through the VIDEO OUT or S VIDEO OUT terminal. Darker: when connected to a TV through the COMPONENT VIDEO OUT (Y/P _B /P _R) terminals.
Audio 	Speaker Setting <u>DVD-A</u> <u>DVD-V</u> (page 20) Choose the settings to suit your audio system and the listening environment.	<u>Multi-channel</u> : when 3 or more speakers are connected. ● Speaker presence and size ● Delay time ● Channel balance <hr/> <u>2-channel</u> : when 2 speakers or an amplifier with a Dolby Pro Logic decoder is connected.
	PCM Down Conversion <u>DVD-A</u> <u>DVD-V</u> (page 21) Select how to output the audio signals on discs that do not have copyright protection.	<u>No</u> Yes
	Dolby Digital <u>DVD-A</u> <u>DVD-V</u> (page 21) Digital output of Dolby Digital signals.	<u>Bitstream</u> PCM
	DTS Digital Surround <u>DVD-A</u> <u>DVD-V</u> (page 21) Digital output of DTS Digital Surround signals.	<u>PCM</u> Bitstream
	D. Range Compression <u>DVD-A</u> <u>DVD-V</u> (Dolby Digital only) Change the dynamic range for late night viewing.	<u>Off</u> On
	Audio during Search <u>DVD-A</u> <u>DVD-V</u> <u>VCD</u> (Remarks below) Choose whether to have sound during search.	<u>On</u> Off
Display 	Menu Language Choose the language for these menus and the on-screen messages.	<u>English</u> Français Español
	On-Screen Messages Choose whether to show on-screen messages or not.	<u>On</u> Off
Others 	DVD-Video Mode Select how to play pictures contained on some DVD-Audio. The setting returns to "Off" when you remove the disc or turn the unit off.	<u>Off</u> (DVD-Audio are played as DVD-Audio.) On (DVD-Video contents found on DVD-Audio can be played.)
	Demo A demonstration of the unit's on-screen displays starts when you select "On". The demonstration stops when you press a button and the setting reverts to "Off".	<u>Off</u> On

Remarks

■ Disc—Audio, Subtitle and Menus

Original: The original language of each disc will be selected.

Other **:** Input a code number with the numbered buttons (page 30).

Automatic: If the language selected for "Audio" is not available, subtitles of that language will automatically appear if available on that disc.

● Some discs are designed to start in a certain language despite any changes you make here.

■ Audio—Audio during Search

Audio will be heard when playing some DVD-Audio despite the settings you make here.

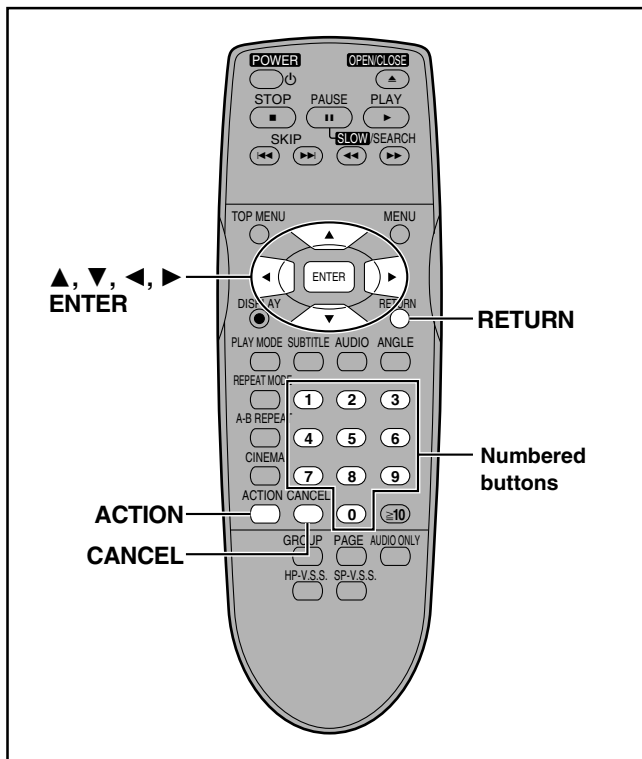

Common procedures

Remote control only

See page 19 for menu and option details.

1 Press [ACTION] to show the menus.

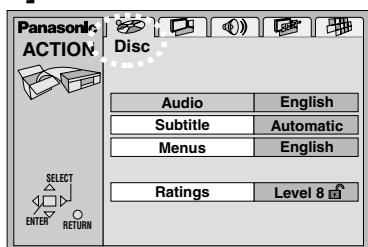

2 Press [◀, ▶] to select the menu's tab. The screen changes to display the menu.

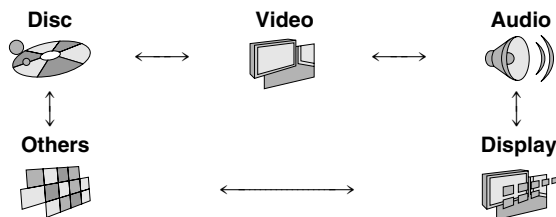

3 Press [▲, ▼] to select the item you want to change and press [ENTER].

4 Press [▲, ▼] to select the option and press [ENTER]. The screen now shows the menu again.

To return to the previous screen
Press [RETURN].

When you are finished
Press [ACTION].

Entering a password (Ratings)

DVD-V

The password screen is shown when you select levels 0 to 7.

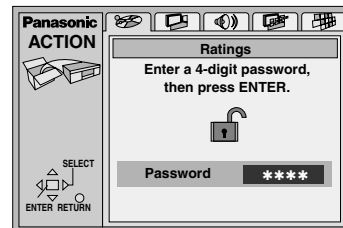

- Input a 4-digit password with the numbered buttons and press [ENTER].
 - If you enter a wrong number, press [CANCEL] to erase it before you press [ENTER].
 - The lock symbol appears closed to show the rating is locked.
 - Do not forget your password.**
- Press [ENTER] to confirm the 4 digits.

Now, when you insert a DVD-Video that exceeds the ratings limit you set, a message appears on the television. Follow the on-screen instructions.

Speaker setting

DVD-A DVD-V

Change **speaker presence and size** (a), **delay time** (b), and **channel balance** (c) to suit the speakers you have connected. These settings are not necessary when you select "2-channel" (only two speakers are connected).

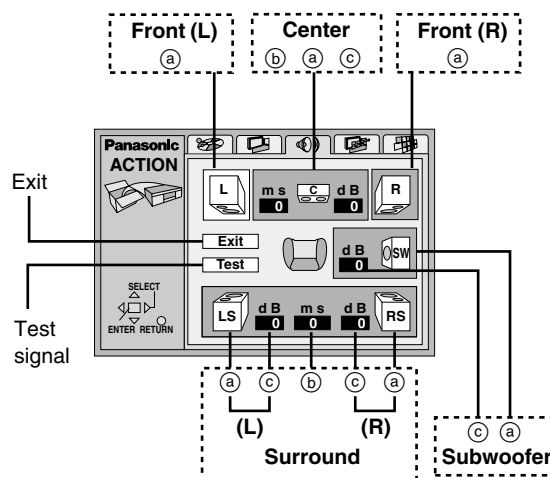

Speaker presence and size (a)

- Press [▲, ▼, ◀, ▶] to select the item and press [ENTER].
- Press [▲, ▼] to select the setting and press [ENTER].

Icon examples: Surround speaker (L)

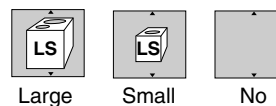

Large: When the speaker supports low-frequency (under 100 Hz) reproduction.

Small: Select when the speaker does not support low-frequency reproduction.

The size setting for the front speakers is automatically determined by the setting for the subwoofer.

Delay time (ⓐ)

DVD-V (Dolby Digital, center and surround speakers only)

For optimum listening with 5.1-channel sound, all the speakers, except for the subwoofer, should be the same distance from the seating position. If you have to place the center or surround speakers closer to the seating position, adjust the delay time to make up for the difference. If distance ⓐ (from the center speaker) and ⓑ (from the surround speakers) are the same as or greater than ⓒ (from the front speakers), leave the delay time as "0", the factory preset. If either distance ⓐ or ⓑ is less than ⓒ, find the difference in the relevant table and change to the recommended setting.

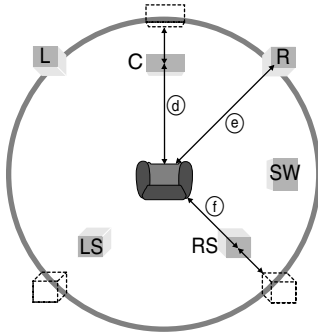

Changing the delay time

1. Press [▲, ▼, ◀, ▶] to select the delay time box and press [ENTER].
2. Press [▲, ▼] to adjust the delay time and press [ENTER].

•Center speaker

Difference	Setting
Approx. 50 cm (1½ feet)	1.3 ms
Approx. 100 cm (3 feet)	2.6 ms
Approx. 150 cm (5 feet)	3.9 ms
Approx. 200 cm (6 feet)	5.3 ms

•Surround speakers

Difference	Setting
Approx. 200 cm (6 feet)	5.3 ms
Approx. 400 cm (12 feet)	10.6 ms
Approx. 600 cm (18 feet)	15.9 ms

Channel balance (ⓒ)

1. Press [▲, ▼, ◀, ▶] to select "Test" and press [ENTER].
A test signal is output from one speaker at a time, starting with the front left speaker and proceeding clockwise.

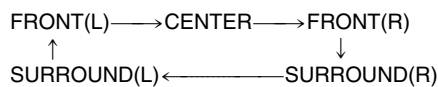

2. While listening to the test signal, press [▲, ▼] to adjust the volume of the center and surround speakers so they are the same apparent volume as the front speakers.
(The front speakers cannot be adjusted here.)
3. Press [ENTER].
The test signal stops.

Note

No signal is output for the subwoofer. To adjust its volume, play something, then return to this screen to adjust to suit your taste.

When you are finished

Press [▲, ▼, ◀, ▶] to select "Exit" and press [ENTER].

Note

The unit may be unable to output as set here due to limitations imposed by the unit itself or the disc being played. (The display's "P.PCM" indicator lights or "D.MIX" indicator goes out in these cases.)

Digital output

DVD-A DVD-V

Change the settings when you have connected equipment through this unit's DIGITAL AUDIO OUT terminal (OPTICAL).

PCM Down Conversion

Select how to output the high-quality audio signals (sampling frequencies of 96 kHz and 88.2 kHz) on discs that do not have copyright protection. Choose the settings to suit the equipment you have connected.

Equipment (Able to handle 88.2 kHz or more)	Setting	Audio output
Yes	No	Output as is
No	Yes	Down-sampled to 48 kHz or 44.1 kHz

The equipment cannot output signals of 88.2 kHz or more if the setting is "No" and the equipment is unable to handle these signals.

Note

- Some equipment cannot handle sampling frequencies of 88.2 kHz, even if they can handle 96 kHz. Read your equipment's operating instructions for details.
- Signals are down-sampled to either 48 kHz or 44.1 kHz despite the above settings if they have a sampling frequency of 176.4 kHz or more or are copyright protected.

Dolby Digital

Bitstream* (Factory preset):

When you have connected a unit with a built-in Dolby Digital decoder.

PCM:

When you have connected a unit that doesn't have a built-in Dolby Digital decoder.*

DTS Digital Surround

PCM (Factory preset):

When you have connected a unit that doesn't have a built-in DTS decoder.*

Bitstream:

When you have connected a unit with a built-in DTS decoder.

*These changes to digital audio output must be made, otherwise bitstream signals the decoder cannot handle will be output. If these signals are output, "noise" will be output which can cause harm to your ears and speakers.

Home Theater—Enjoying more powerful sound

This unit has built-in Dolby Digital and DTS decoders (⇒ page 25).

You can enjoy the powerful movie theater and hall-like sound available with Dolby Digital and DTS by connecting an amplifier with 5.1-channel input terminals. You do not need to purchase separate Dolby Digital or DTS decoders.

Use analog connection to enjoy audio recorded with high sampling frequencies (over 48 kHz). Some of this material is copy-guarded and will be down-sampled if you use digital connection.

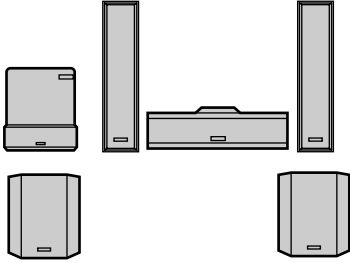
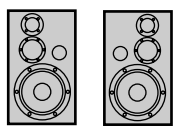
What you want to do	How to do it	Reference page	Settings	Reference page
To enjoy 5.1-channel surround sound 	Analog connection Connect to an amplifier with 5.1-channel audio input terminals.	23 A	Speaker Setting Select "Multi-channel".	20
	Digital connection Connect to an amplifier with built-in decoder or a separate decoder-amplifier combination.	23 B	PCM Down Conversion Dolby Digital DTS Digital Surround Change the settings to suit the equipment you connect. Make the speaker settings on the amplifier or decoder.	21 —
To enjoy stereo or Dolby Pro Logic 	Analog connection Connect to an analog amplifier or system component.	24 C	PCM Down Conversion Dolby Digital and DTS Digital Surround Select "PCM".	21
	Digital connection Connect to a digital amplifier or system component.	24 D		

Note

- The equipment connections described are examples.
- Peripheral equipment and optional cables sold separately unless otherwise indicated.
- Before connection, turn off all equipment and read the appropriate operating instructions.

Recording to cassette tapes or digital recording equipment

■ **Analog recording**

You can record to a cassette deck or other recording equipment. Using analog connection means sound will be unaffected by the copy guards found on DVDs.

To make an analog recording

Connect the recording equipment with an audio cable (⇒ **C** page 24).

■ **Digital recording**

You can record the digital signal directly to digital recording equipment.

When recording DVDs, the signals must be converted to a signal the recording equipment can handle. Use analog connection if the signals are copy-guarded.

To make a digital recording

1. Connect the recording equipment with an optical digital audio cable (⇒ **D** page 24).
2. When recording DVDs, make the following settings.
 ADVANCED SURROUND (V.S.S.): OFF (⇒ page 11)
 PCM Down Conversion: Yes (⇒ page 21)
 Dolby Digital and DTS Digital Surround: PCM (⇒ page 21)

A Connecting an amplifier with 5.1-channel audio input terminals

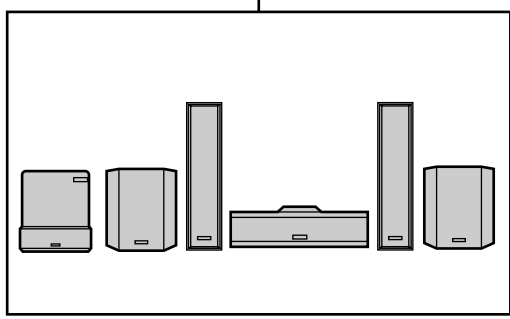
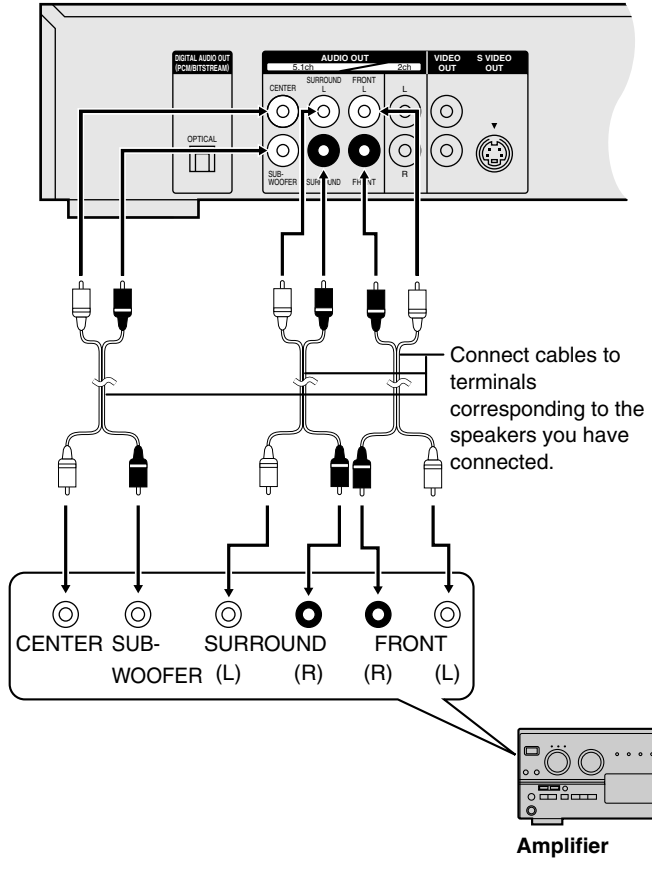
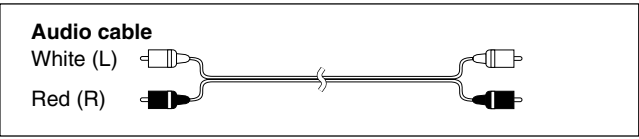

Speakers
 You can enjoy surround sound by connecting from three to six speakers.
 Example: Six speakers

Change “Speaker setting” (⇒ page 20).

Note

- Turn speaker and headphone V.S.S. (⇒ page 11) off when you connect through the 5.1-channel output terminals. The unit does not output the signals for channels other than the front speakers when V.S.S. is on.
- If you do not connect a subwoofer, it is advisable to connect front speakers (L/R) capable of producing bass of less than 100 Hz.

B Connecting an amplifier with a built-in decoder or a decoder-amplifier combination

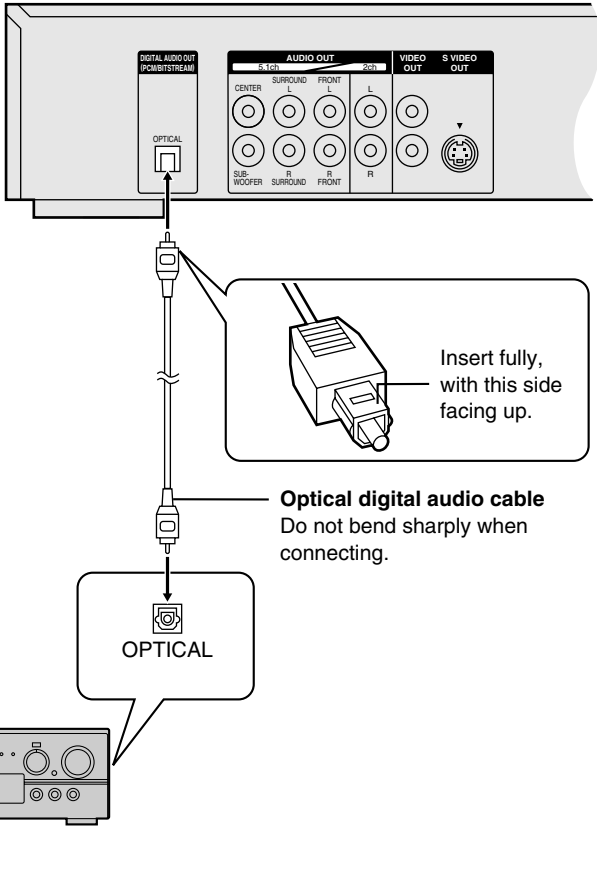

Optical digital audio cable
 Do not bend sharply when connecting.

Change “Digital output” (⇒ page 21).

Note

You cannot use DTS Digital Surround decoders not suited to DVD-Video.

C Connecting an analog amplifier or system component

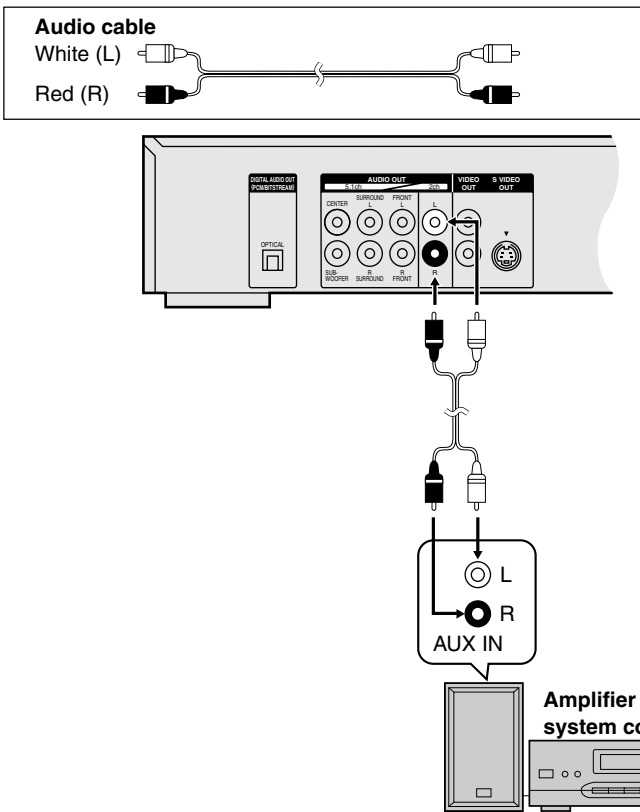

D Connecting a digital amplifier or system component

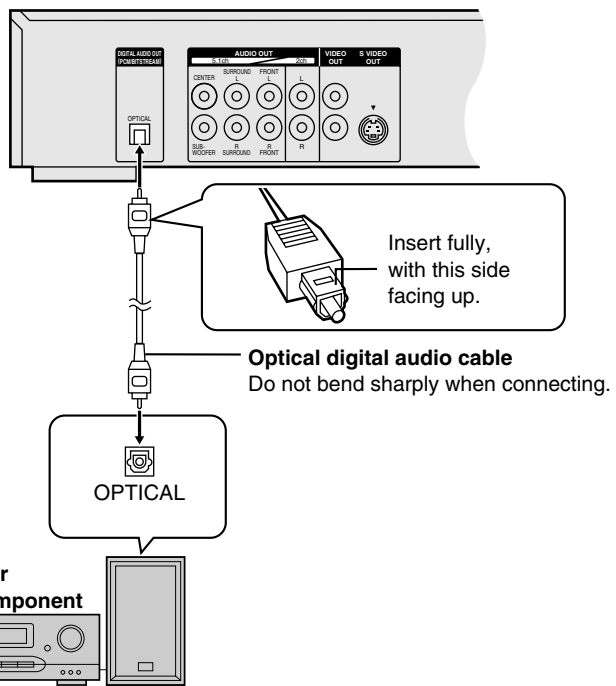

Change “Digital output” (⇒ page 21).

To enjoy Dolby Pro Logic

- If you connect an amplifier that can decode Dolby Pro Logic, you will also need to connect center and surround speakers to enjoy surround sound. Read the instructions for the equipment for connection details.
- Turn Advanced Surround off (⇒ page 11). Dolby Pro Logic will not function correctly if Advanced Surround is on.

Disc handling

Do not use irregularly shaped discs, such as heart-shaped. (These can damage the unit.)

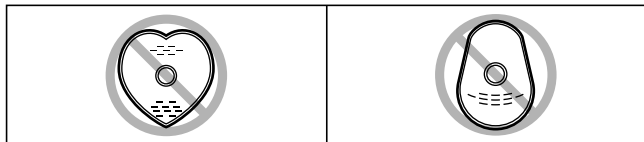

How to hold a disc

Do not touch the recorded surface.

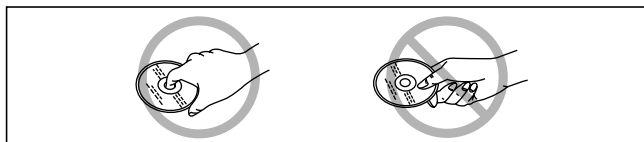

If the surface is dirty

DVD-Audio, DVD-Video, Video CD, CD

Wipe with a damp cloth and then wipe dry. Wipe from the center toward the circumference.

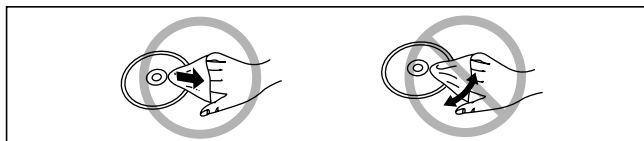

DVD-R

- Clean only with DVD-RAM/PD disc cleaner, available from Panasonic dealers, part number LF-K200DCA1.
- Never use cloths or cleaners for CDs, etc.

If the disc is brought from a cold to a warm environment, moisture may form on the disc

If the disc is a DVD-R, use the DVD-RAM/PD disc cleaner (LF-K200DCA1, available from Panasonic dealers) to wipe dry. Wipe with a soft, dry, lint-free cloth before using other discs.

Handling precautions

- Do not write on the label side with a ball-point pen or other writing instrument.
- Do not use record cleaning sprays, benzene, thinner, static electricity prevention liquids or any other solvent.
- Do not attach labels or stickers to discs. (Do not use discs with exposed adhesive from tape or left over peeled-off stickers.)
- Do not use scratch-proof protectors or covers.
- Do not use discs printed with label printers available on the market.

Do not place or store discs in the following places

- Locations exposed to direct sunlight
- Humid or dusty locations
- Locations directly exposed to a heat vent or heating appliance

Bitstream

This is the digital form of multiple channel audio data (e.g., 5.1 channel) before it is decoded into its various channels.

Decoder

A decoder restores the coded audio signals on DVDs to normal. This is called decoding.

Dolby Digital

This is a method of coding digital signals developed by Dolby Laboratories. Apart from stereo (2-channel) audio, these signals can also be 5.1-channel audio. A large amount of audio information can be recorded on one disc using this method.

Dolby Pro Logic

A surround system where a 4-channel audio track is recorded as 2 channels and then is restored to 4 channels for play. The surround channel is monaural and can reproduce up to 7 kHz.

DTS (Digital Theater Systems)

This surround system is used in many movie theaters around the world. There is good separation between the channels, so realistic sound effects are possible.

Dynamic range

Dynamic range is the difference between the lowest level of sound that can be heard above the noise of the equipment and the highest level of sound before distortion occurs.

Frame still and field still

Frames are the still pictures that go together to make a moving picture. There are about 30 frames shown each second.

One frame is made up of two fields. A regular television shows these fields one after the other to create frames.

A still is shown when you pause a moving picture. A frame still is made up of two alternating fields, so the picture may appear blurred, but overall quality is high.

A field still is not blurred, but it has only half the information of a frame still so picture quality is lower.

I/P/B

MPEG 2, the video compression standard adopted for use with DVD-Video, codes frames using these 3 picture types.

I: Intra coded picture (I-picture)

This is the standard picture and is a complete picture in itself.

This means it has the best picture quality and is the best to use when adjusting the picture.

P: Predictive coded picture (P-picture)

This picture is calculated based on past I or P-pictures.

B: Bidirectionally-predictive coded picture (B-picture)

This picture is calculated by comparing past and future I and P-pictures so it has the lowest volume of information.

Linear PCM (pulse code modulation)

PCM is the usual digital method used for music CDs. DVDs have a greater volume so they use linear PCM, which has a higher sampling rate. Compressed PCM signals are called packed PCM (PPCM).

MP3

MP3 refers to the type of music file that is compressed using MPEG audio layer 3. A file is a single audio track and is treated as a chapter on this unit. A folder (album) is treated as a title on this unit.

When making MP3 discs to play on this unit

Disc format

Conform to ISO9660 level 1 and level 2

File format

MP3 files that have the suffix “.MP3” or “.mp3”.

To play in a certain order

Prefix the folder and file names with numbers with the same number of digits at the time of recording.

Files may not be recorded in the numbered order if the prefixes have different numbers of digits, for example 1.mp3, 2.mp3, 10.mp3. Some writing software may also cause recording to occur in a different order.

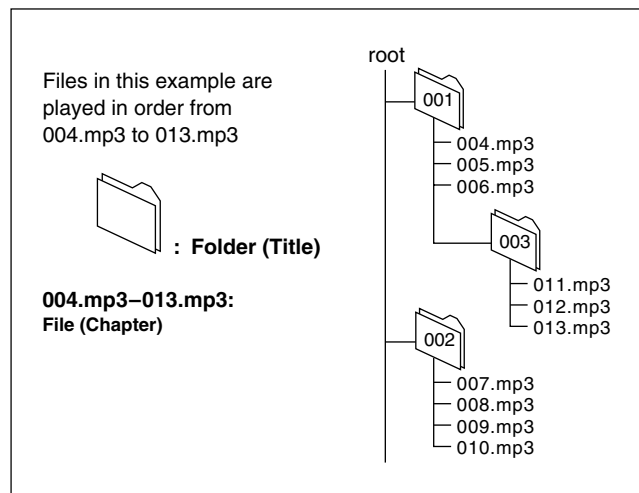

Pan&Scan/Letterbox

In general, DVD-Video are produced with the intention that they be viewed on a widescreen television with an aspect ratio of 16:9. This means you can view most material with the intended aspect ratio on a widescreen television.

Material with this ratio will not fit onto a standard television with an aspect ratio of 4:3. Two styles of picture, “Pan&Scan” and “Letterbox”, deal with this problem.

Pan&Scan: The sides are cut off so the picture fills the screen.

Letterbox: Black bands appear at the top and bottom of the picture so the picture itself appears in an aspect ratio of 16:9.

Playback control (PBC)

If a Video CD has playback control, you can select scenes and information with menus (called menu play in these instructions).

Title/Chapter

DVD-Video are divided up into large sections, titles, and smaller sections, chapters. The numbers allocated to these sections are called title numbers and chapter numbers.

Track

This is the smallest division on DVD-Audio, CD, and Video CD, and usually equates to a single song.

Troubleshooting guide

Before requesting service, make the below checks. If you are in doubt about some of the check points, or if the remedies indicated in the chart do not solve the problem, contact the Panasonic Customer Call Center at 1-800-211-7262, or e-mail consumerproducts@panasonic.com, or web site (<http://www.panasonic.com>).

Reference pages are shown as black circled numbers ⑤.

Power

<p>No power.</p> <p>The unit is automatically switched to the standby mode.</p>	<ul style="list-style-type: none"> ● Insert the AC power supply cord securely into the household AC outlet. ⑥ ● To conserve power, the unit automatically switches to standby after approximately 30 minutes in the stop mode. Turn the power back to ON.
---	---

Operation

<p>No response when buttons pressed.</p>	<ul style="list-style-type: none"> ● Some operations may be prohibited by the disc. ● The unit may not be operating properly due to lightning, static electricity or some other external factor. <p>Reset procedure: Press [⏻, POWER] to switch the unit to the standby mode and then back to ON. Alternatively, press [⏻, POWER] to switch the unit to the standby mode, disconnect the AC power supply cord, and then reconnect it.</p>
<p>No operations can be performed with the remote control.</p>	<ul style="list-style-type: none"> ● Check the batteries are installed correctly. ⑤ ● The batteries are depleted: Replace them with new ones. ⑤ ● Point the remote control at the remote control sensor and operate. ⑤
<p>Play fails to start even when [▶] (PLAY) is pressed. Play starts but then stops immediately.</p>	<ul style="list-style-type: none"> ● Condensation has formed: Wait 1 to 2 hours for it to evaporate. ● This unit cannot play discs other than DVD-Audio, DVD-Video, Video CD and CD. ⑤ ● This unit cannot play DVD-Video with a region number other than "1", "ALL" or multiple region numbers including "1". ⑤ ● The disc may be dirty and may require cleaning. 24 ● Ensure that the disc is installed with the label of the side to be played facing upwards. ③
<p>Alternative languages fail to be selected.</p>	<ul style="list-style-type: none"> ● An alternative language is not selected with discs which do not contain more than one language. ● In the case of some discs, the alternative language cannot be selected with [AUDIO] or [SUBTITLE]. Try selecting it from the disc's menu if one is available. ⑨
<p>No subtitles.</p>	<ul style="list-style-type: none"> ● Subtitles appear only with discs that contain them. ● Subtitles are cleared from the television. Display the subtitles. 15
<p>Soundtrack and/or subtitle language is not the one selected with the ACTION menus.</p>	<ul style="list-style-type: none"> ● The language is not recorded on the disc.
<p>Angle cannot be changed.</p>	<ul style="list-style-type: none"> ● This function is dependent on software availability. Even if a disc has a number of angles recorded, these angles may be recorded for specific scenes only. 15
<p>Dialogue Enhancer has no effect.</p>	<ul style="list-style-type: none"> ● This feature does not work when the unit is outputting bitstream signals.
<p>You have forgotten your ratings password. Reset all the settings to Factory Preset.</p>	<ul style="list-style-type: none"> ● While stopped, press and hold [◀◀] and [] on the unit and then also press and hold [▲] on the unit until "Initialized" disappears from the television. Turn the unit off and on again. All settings will return to the default values.

Sound

<p>No sound.</p> <p>Distorted sound.</p>	<ul style="list-style-type: none"> ● Check the connections. ⑥ 23 24 ● Check the volume on the equipment you have connected. ● Ensure that the input settings for the television and stereo system are correct. ● If you have connected this unit to an amplifier through the AUDIO OUT (5.1ch) terminals, go to the Audio menu in the ACTION menus, and change "Speaker Setting" to suit your speakers. Select the large or small icon for all the speakers you have connected. 20 ● Turn Advanced Surround off if it causes distortion. 11 ● Output from this unit will be in stereo (two channels) when Advanced Surround is on. Turn Advanced Surround off if you are using analog connection with three or more speakers. 11 ● Due to the specifications on some types of televisions, both video and audio may be cut off when you turn the AUDIO ONLY feature on. 11 ● If the "D.MIX" indicator on the unit's display goes out while playing a multi-channel DVD-Audio disc, sound will only be output from speakers specified by the disc. Read the disc's instructions for details.
<p>Piercing noise comes from the speakers.</p>	<ul style="list-style-type: none"> ● If you have connected this unit to other equipment through the DIGITAL AUDIO OUT terminal, ensure you have selected the correct settings for "Dolby Digital" and "DTS Digital Surround" in the ACTION menu's Audio menu. 21

Picture

Picture distorted.	<ul style="list-style-type: none"> Some distortion is normal during SEARCH. The screen may be disrupted briefly when you turn on and off the AUDIO ONLY feature. ①
No picture.	<ul style="list-style-type: none"> Ensure that the equipment is connected properly. ③ Make sure the television is on. Ensure the television's video input setting (e.g., VIDEO 1) is correct. If "This disc is PAL system. The output is sound only." is on the television, then you have loaded a PAL system DVD-Audio and only the audio portion of the disc can be played.
The picture shown on the television is not normal. (The sides of the picture are cut off or black bands appear at the top and bottom of the screen.)	<ul style="list-style-type: none"> Go to the Video menu in the ACTION screen, and change "TV Aspect" to suit your television. You may also need to change the screen mode on the television itself. ⑦ Ensure that the unit is connected directly to the television, and is not connected through a video cassette recorder.
Picture quality is poor.	<ul style="list-style-type: none"> Check the settings in the on-screen menu's video menu. ⑮

Displays

"NO PLAY" appears on the unit's display.	<ul style="list-style-type: none"> You inserted a disc the unit cannot play; insert one it can. ⑤
No on-screen display.	<ul style="list-style-type: none"> Go to Display in the ACTION menus, and select "On" for "On-Screen Messages". ⑮
On-Screen Menu Icons not displayed or only partially displayed on the television.	<ul style="list-style-type: none"> Press [▲, ▼] while the rightmost icon is highlighted to move them down. ⑮
The disc's menu is displayed in a different language.	<ul style="list-style-type: none"> Go to Disc in the ACTION menus, and select the preferred language for "Menus". ⑮
No menu play.	<ul style="list-style-type: none"> Menus are only displayed if they are recorded on the disc.
"CHECK THE DISC" appears on the unit's display.	<ul style="list-style-type: none"> Disc is dirty. Wipe the disc clean. ⑳
"ERROR" appears on the unit's display.	<ul style="list-style-type: none"> The track playing has been recorded with a nonstandard system.
"H□□" appears on the unit's display. □□ stands for a number.	<ul style="list-style-type: none"> Trouble is likely to have occurred. The number following "H" depends on the status of the unit. Reset procedure: Press [⏻, POWER] to switch the unit to the standby mode and then back to ON. Alternatively, press [⏻, POWER] to switch the unit to the standby mode, disconnect the AC power supply cord, and then reconnect it. If the service numbers fail to clear, note the service number and contact a qualified service person.
"NO DISC" appears on the unit's display.	<ul style="list-style-type: none"> You haven't inserted a disc; insert one. You haven't inserted the disc correctly; insert it correctly. ③

Maintenance

To clean this unit, wipe with a soft, dry cloth.

- Never use alcohol, paint thinner or benzene to clean this unit.
- Before using chemically treated cloth, read the instructions that came with the cloth carefully.

Panasonic

Technics

Quasar

*For Product Information, Operating Assistance, Literature Request, Dealer Locations, and all Customer Service inquiries please contact:
1-800-211-PANA (7262), Monday–Friday 9 am–9 pm; Saturday–Sunday 9 am–7 pm, EST.*

*Web Site: <http://www.panasonic.com>
You can purchase parts, accessories or locate your nearest servicenter by visiting our Web Site.*

Accessory Purchases:

1-800-332-5368 (Customer Orders Only)
Panasonic Services Company 20421 84th Avenue South, Kent, WA 98032
(6 am to 5 pm Monday–Friday; 6 am to 10:30 am Saturday; PST)
(Visa, MasterCard, Discover Card, American Express, Check)

Factory Servicenters Locations

<p>CALIFORNIA 6550 Katella Avenue Cypress, CA 90630</p> <p>800 Dubuque Avenue S. San Francisco CA 94080</p> <p>3878 Ruffin Road Suite A San Diego, CA 92123</p> <p>FLORIDA 3700 North 29th Avenue Suite 102 Hollywood, FL 33020</p>	<p>GEORGIA 8655 Roswell Road Suite 100 Atlanta, GA 30350</p> <p>ILLINOIS 1709 North Randall Road Elgin, IL 60123</p> <p>MASSACHUSETTS 60 Glacier Drive Suite G Westwood, MA 02090</p>	<p>MINNESOTA 7850-12th Avenue South Airport Business Center Bloomington, MN 55425</p> <p>OHIO 2236 Waycross Road Civic Center Plaza Forest Park, OH 45240</p> <p>PENNSYLVANIA 2221 Cabot Blvd. West Suite B Langhorne, PA 19047</p>	<p>TEXAS 13615 Welch Road Suite 101 Farmers Branch TX 75244</p> <p>WASHINGTON 20425-84th Avenue South Kent, WA 98032</p> <p>HAWAII 99-859 Iwaiwa Street Aiea, Hawaii 96701 Phone (808) 488-1996 Fax (808) 486-4369</p>
--	--	---	--

Reference

Service in Puerto Rico

**Matsushita Electric of Puerto Rico, Inc. Panasonic Sales Company/Factory Servicenter:
Ave. 65 de Infanteria, Km. 9.5, San Gabriel Industrial Park, Carolina, Puerto Rico 00985
Phone (787) 750-4300 Fax (787) 768-2910**

Limited Warranty

Panasonic Consumer Electronics Company,
Division of Matsushita Electric Corporation of America
One Panasonic Way Secaucus, New Jersey 07094

Panasonic Sales Company, Division of Matsushita Electric
of Puerto Rico, Inc.
Ave. 65 de Infantería, Km. 9.5
San Gabriel Industrial Park, Carolina, Puerto Rico 00985

Panasonic/Technics DVD Player Limited Warranty

Panasonic Consumer Electronics Company or Panasonic Sales Company (collectively referred to as "the Warrantor") will repair or replace this product with new or refurbished parts or equivalent product, free of charge in the U.S.A. or Puerto Rico, in the event of a defect in materials or workmanship as follows (all time periods commence from the date of original purchase):

Parts—New or rebuilt parts in exchange for defective parts for one (1) year from the date of original purchase.

Labor—Carry-in or mail-in service for ninety (90) days from the date of original purchase. After the ninety (90) day labor period, purchaser pays for all labor charges.

Batteries—(if included) New rechargeable batteries in exchange for defective rechargeable batteries for ten (10) days from the date of the original purchase. Non-rechargeable batteries are not warranted.

Carry-in or mail-in service in the USA can be obtained during the warranty period by contacting a Panasonic Services Company (PASC) Factory Servicenter listed in the Servicenter Directory. Or call, toll free, 1-800-211-7262 to locate an authorized PASC Servicenter. Carry-in or mail-in service in Puerto Rico can be obtained during the warranty period by calling the local telephone number in the Servicenter Directory.

This warranty is extended only to the original purchaser.

A purchase receipt or other proof of date of original purchase will be required before warranty service is rendered.

This warranty only covers failures due to defects in materials and workmanship which occur during normal use and does not cover normal maintenance. The warranty does not cover damages which occurred in shipment, or failures which are caused by products not

supplied by the warrantor, or failures which result from accident, misuse, abuse, neglect, mishandling, faulty installation, misapplication, improper set-up adjustments, operation or maintenance, alteration, modification, power line surge, lightning damage, interference, commercial use such as hotel, office, restaurant, or other business or rental use of the product, or serviced by anyone other than an PASC Factory Servicenter or an authorized PASC Servicenter, or damage that is attributable to acts of God.

LIMITS AND EXCLUSIONS

There are no express warranties except as listed above.

THE WARRANTOR SHALL NOT BE LIABLE FOR INCIDENTAL OR CONSEQUENTIAL DAMAGES RESULTING FROM THE USE OF THIS PRODUCT, OR ARISING OUT OF ANY BREACH OF THIS WARRANTY, INCLUDING WITHOUT LIMITATIONS, DAMAGE TO DISCS. ALL EXPRESS AND IMPLIED WARRANTIES, INCLUDING THE WARRANTIES OF MERCHANTABILITY, AND FITNESS FOR A PARTICULAR PURPOSE, ARE LIMITED TO THE APPLICABLE WARRANTY PERIOD SET FORTH ABOVE.

Some states do not allow the exclusion or limitation of incidental or consequential damages, or limitations on how long an implied warranty lasts, so the above exclusions or limitations may not apply to you.

This warranty gives you specific legal rights and you may also have other rights which vary from state to state.

If a problem with this product develops during or after the warranty period, you may contact your dealer or Servicenter. If the problem is not handled to your satisfaction, then write to the Consumer Affairs Department at the company address indicated above.

If you ship the product

Carefully pack and send it prepaid, adequately insured and preferably in the original carton.

Attach a postage-affixed letter, detailing the complaint, to the outside of the carton.

Do NOT send the product to the Executive or Regional Sales offices. They are NOT equipped to make repairs.

Product Service

- 1. Damage requiring service**—The unit should be serviced by qualified service personnel if:
 - (a) The AC power supply cord or AC adaptor has been damaged; or
 - (b) Objects or liquids have gotten into the unit; or
 - (c) The unit has been exposed to rain; or
 - (d) The unit does not operate normally or exhibits a marked change in performance; or
 - (e) The unit has been dropped or the cabinet damaged.
- 2. Servicing**—Do not attempt to service the unit beyond that described in these operating instructions. Refer all other servicing to authorized servicing personnel.
- 3. Replacement parts**—When parts need replacing ensure the servicer uses parts specified by the manufacturer or parts that have the same characteristics as the original parts. Unauthorized substitutes may result in fire, electric shock, or other hazards.
- 4. Safety check**—After repairs or service, ask the servicer to perform safety checks to confirm that the unit is in proper working condition.

Product information

For product information or assistance with product operation:

Contact the Panasonic Customer Call Center at 1-800-211-7262, or e-mail consumerproducts@panasonic.com, or web site (<http://www.panasonic.com>).



As an ENERGY STAR® Partner, Panasonic has determined that this product meets the ENERGY STAR® guidelines for energy efficiency.

Language code list

Abkhazian:	6566	Chinese:	9072	Hausa:	7265	Lithuanian:	7684	Romanian:	8279	Telugu:	8469
Afar:	6565	Corsican:	6779	Hebrew:	7387	Macedonian:	7775	Russian:	8285	Thai:	8472
Afrikaans:	6570	Croatian:	7282	Hindi:	7273	Malagasy:	7771	Samoan:	8377	Tibetan:	6679
Albanian:	8381	Czech:	6783	Hungarian:	7285	Malay:	7783	Sanskrit:	8365	Tigrinya:	8473
Ameharic:	6577	Danish:	6865	Icelandic:	7383	Malayalam:	7776	Scots Gaelic:	7168	Tonga:	8479
Arabic:	6582	Dutch:	7876	Indonesian:	7378	Maltese:	7784	Serbian:	8382	Turkish:	8482
Armenian:	7289	English:	6978	Interlingua:	7365	Maori:	7773	Serbo-Croatian:	8372	Turkmen:	8475
Assamese:	6583	Esperanto:	6979	Irish:	7165	Marathi:	7782	Shona:	8378	Twi:	8487
Aymara:	6588	Estonian:	6984	Italian:	7384	Moldavian:	7779	Sindhi:	8368	Ukrainian:	8575
Azerbaijani:	6590	Faroese:	7079	Japanese:	7465	Mongolian:	7778	Singhalese:	8373	Urdu:	8582
Bashkir:	6665	Fiji:	7074	Javanese:	7487	Nauru:	7865	Slovak:	8375	Uzbek:	8590
Basque:	6985	Finnish:	7073	Kannada:	7578	Nepali:	7869	Slovenian:	8376	Vietnamese:	8673
Bengali; Bangla:	6678	French:	7082	Kashmiri:	7583	Norwegian:	7879	Somali:	8379	Volapük:	8679
Bhutani:	6890	Frisian:	7089	Kazakh:	7575	Oriya:	7982	Spanish:	6983	Welsh:	6789
Bihari:	6672	Galician:	7176	Kirghiz:	7589	Pashto, Pushto:	8083	Sundanese:	8385	Wolof:	8779
Breton:	6682	Georgian:	7565	Korean:	7579	Persian:	7065	Swahili:	8387	Xhosa:	8872
Bulgarian:	6671	German:	6869	Kurdish:	7585	Polish:	8076	Swedish:	8386	Yiddish:	7473
Burmese:	7789	Greek:	6976	Laotian:	7679	Portuguese:	8084	Tagalog:	8476	Yoruba:	8979
Byelorussian:	6669	Greenlandic:	7576	Latin:	7665	Punjabi:	8065	Tajik:	8471	Zulu:	9085
Cambodian:	7577	Guarani:	7178	Latvian, Lettish:	7686	Quechua:	8185	Tamil:	8465		
Catalan:	6765	Gujarati:	7185	Lingala:	7678	Rhaeto-Romance:	8277	Tatar:	8484		

Manufactured under license from Dolby Laboratories. "Dolby", "Pro Logic" and the double-D symbol are trademarks of Dolby Laboratories.

Manufactured under license from Digital Theater Systems, Inc. US Pat. No.5,451,942, 5,956,674, 5,974,380, 5,978,762 and other world-wide patents issued and pending. "DTS" and "DTS Digital Surround" are registered trademarks of Digital Theater Systems, Inc. © 1996, 2000 Digital Theater Systems, Inc. All rights reserved.

Apparatus Claims of U.S. Patent Nos. 4,631,603, 4,577,216, and 4,819,098, licensed for limited viewing uses only.

This product incorporates copyright protection technology that is protected by method claims of certain U.S. patents and other intellectual property rights owned by Macrovision Corporation and other rights owners. Use of this copyright protection technology must be authorized by Macrovision Corporation, and is intended for home and other limited viewing uses only unless otherwise authorized by Macrovision Corporation. Reverse engineering or disassembly is prohibited.

Guía de referencia rápida en español

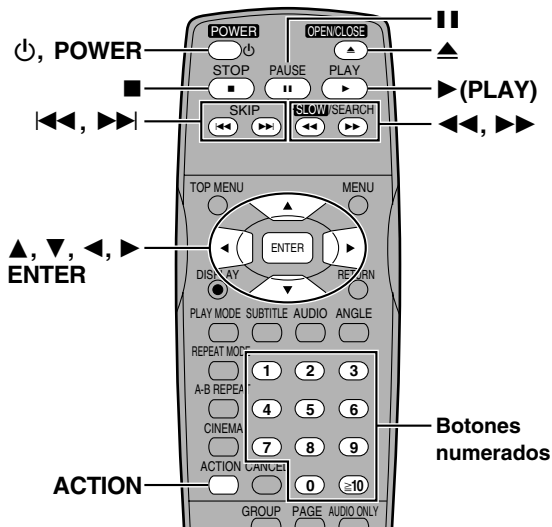

Conexión a un televisor

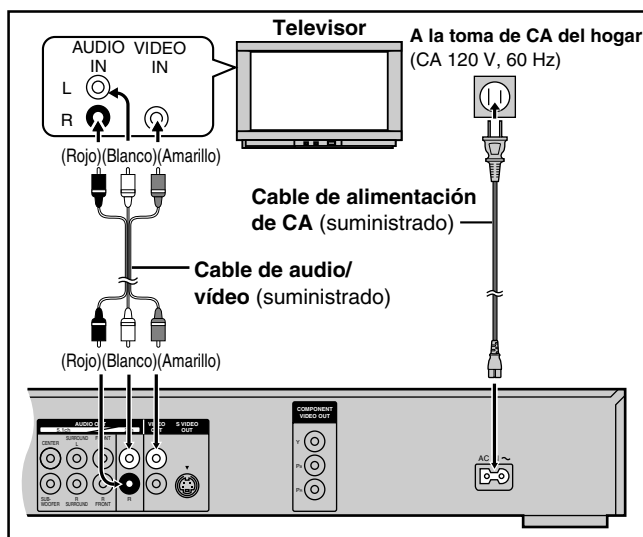

Cambio del idioma de la pantalla

Mando a distancia solamente

- 1 Pulse [POWER] para encender el aparato.
- 2 Pulse [ACTION] para visualizar los menús.
- 3 Pulse [◀, ▶] para seleccionar la lengüeta "Display".
- 4 Pulse [▲, ▼] para seleccionar "Menu Language" y pulse [ENTER].
- 5 Pulse [▲, ▼] para seleccionar "Español" y pulse [ENTER].
- 6 Pulse [ACTION] para finalizar los ajustes.

Selección del tipo de pantalla del televisor

Mando a distancia solamente

- 1 Pulse [POWER] para encender el aparato.
- 2 Pulse [ACTION] para visualizar los menús.
- 3 Pulse [◀, ▶] para seleccionar la lengüeta "Video".
- 4 Pulse [▲, ▼] para seleccionar "Pantalla de la TV" y pulse [ENTER].
- 5 Pulse [▲, ▼] para seleccionar el elemento y pulse [ENTER].
4:3 Pan&Scan (ajuste de fábrica)/4:3 Letterbox/16:9
- 6 Pulse [ACTION] para finalizar los ajustes.

Reproducción básica

DVD-A DVD-V VCD CD

- 1 Pulse [▲] para abrir la bandeja del disco y coloque el disco.
- 2 Pulse [▶] (PLAY).
La bandeja del disco se cierra y la reproducción empieza.

Para detener la reproducción

Pulse [■].

Para hacer una pausa

Pulse [⏸] durante la reproducción.

Pulse [▶] (PLAY) para volver a iniciar la reproducción.

Cuando un menú aparece en el televisor

DVD-A DVD-V VCD

Pulse los botones numerados para seleccionar un elemento.

Función de reanudación

La posición en la que usted detiene la reproducción es grabada por el aparato cuando parpadea "▷" en el visualizador del mismo.

Para reanudar la reproducción

Pulse [▶] (PLAY) mientras parpadea "▷" en el visualizador del aparato.

Salto de capítulos o pistas

DVD-A DVD-V VCD CD

Durante la reproducción o durante la pausa

Pulse [◀◀] o [▶▶].

Visión cuadro a cuadro

DVD-A DVD-V VCD

Mando a distancia solamente

Durante la pausa

Pulse [◀] o [▶].

Avance rápido y rebobinado—SEARCH

DVD-A DVD-V VCD CD

Durante la reproducción

Pulse [◀◀] o [▶▶].

Mantenga pulsado [◀◀, ▶▶] en la unidad principal.

Reproducción a cámara lenta

DVD-A DVD-V VCD

Durante la pausa

Pulse [◀◀] o [▶▶].

Mantenga pulsado [◀◀, ▶▶] en la unidad principal.

- La velocidad de la búsqueda y la de cámara lenta aumenta hasta un máximo de 5 pasos.
- Pulse [▶] (PLAY) para reiniciar la reproducción.
- No puede retroceder con un CD de vídeo durante la reproducción cuadro a cuadro o a cámara lenta.
- Las funciones de cuadro a cuadro y cámara lenta sólo se activan en las partes de imagen en movimiento de los discos DVD de audio.
- [◀◀], [◀], [◀◀]: Retroceso
[▶▶], [▶], [▶▶]: Avance

Specifications

Operating temperature range: +5 to +35 °C (+41 to +95 °F)

Operating humidity range: 5 to 90 % RH (no condensation)

Playable disc type:

- (1) DVD-Video
DVD-R (DVD-Video compatible)
- (2) DVD-Audio
- (3) CD-Audio (CD-DA)
- (4) Video CD
- (5) CD-R/CD-RW (CD-DA, Video CD formatted discs)
- (6) MP3
 - Maximum number of chapters and titles recognizable: 999 chapters and 511 titles
 - Compatible compression rate: between 32 kbps and 320 kbps

Signal system: NTSC

Video output:

Output level: 1 Vp-p (75 Ω)
Output terminal: Pin jack
Number of terminals: 2 systems

S video output:

Y output level: 1 Vp-p (75 Ω)
C output level: 0.286 Vp-p (75 Ω)
Output terminal: S terminal
Number of terminals: 1 system

Component video output:

Y output level: 1 Vp-p (75 Ω)
P_B output level: 0.7 Vp-p (75 Ω)
P_R output level: 0.7 Vp-p (75 Ω)
Output terminal: Pin jack
(Y: green, P_B: blue, P_R: red)
Number of terminals: 1 system

Audio output:

Output level: 2 Vrms (1 kHz, 0 dB)
Output terminal: Pin jack
Number of terminals:
2CH: 1 system
5ch discrete output (5.1ch): 1 system

Audio signal output characteristics:

- (1) Frequency response:
 - DVD (linear audio): 4 Hz–22 kHz (48 kHz sampling)
4 Hz–44 kHz (96 kHz sampling)
 - DVD-Audio: 4 Hz–88 kHz (192 kHz sampling)
 - CD audio: 4 Hz–20 kHz
- (2) S/N ratio:
 - CD audio: 115 dB
- (3) Dynamic range:
 - DVD (linear audio): 102 dB
 - CD audio: 98 dB
- (4) Total harmonic distortion:
 - CD audio: 0.0025 %

Digital audio output:

Optical digital output: Optical terminal

Phones jack:

Wave length: Stereo, 6.3 mm (1/4") jack
Laser power: 658 nm/790 nm
CLASS IIa/CLASS I

Power supply:

AC 120 V, 60 Hz

Power consumption:

14 W

Dimensions:

430 (W)×248 (D)×82 (H) mm
[16^{15/16}" (W)×9^{3/4}" (D)×3^{1/4}" (H)]
(excluding protrusions)

Mass:

2.6 kg (5.7 lb.)

Power consumption in standby mode: approx. 2 W

Note

Specifications are subject to change without notice.
Mass and dimensions are approximate.

**Panasonic Consumer Electronics
Company, Division of Matsushita
Electric Corporation of America**
One Panasonic Way Secaucus,
New Jersey 07094
<http://www.panasonic.com>

**Panasonic Sales Company,
Division of Matsushita Electric
of Puerto Rico, Inc. ("PSC")**
Ave. 65 de Infantería, Km. 9.5
San Gabriel Industrial Park, Carolina,
Puerto Rico 00985

